

Tractor Safety

For the Landscaping and Horticultural Services Industry

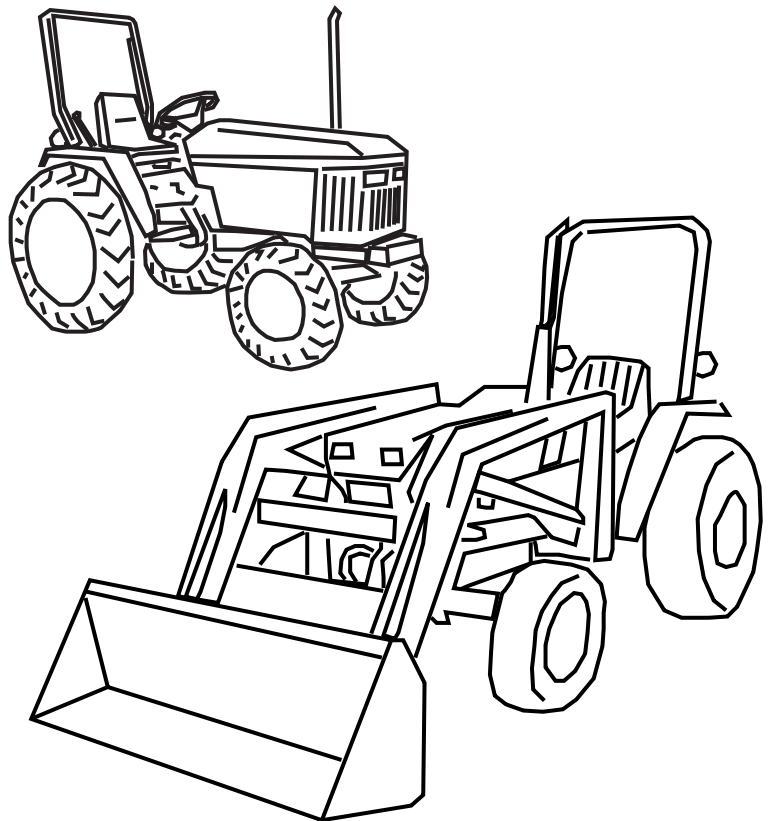

KSTATE Research and
Kansas State University Extension

*“Knowledge
for Life”*

Tractor Safety

Contents

Introduction What's Inside?.....	3
Lesson 1 Take Control of Your Own Safety	4
Lesson 2 Prepare for Safe Operation	8
Lesson 3 Avoid Rollover Accidents	12
Lesson 4 Avoid Run Over Accidents and Collisions	16
Lesson 5 Moving Parts and Machinery Hazards	20
Lesson 6 Highway Safety and Other Hazards.	24
Conclusion.....	32
Quiz Yourself Solutions.....	34

Disclaimer

This material was produced under grant number 46G3-HT04 from the Occupational Safety and Health Administration, U.S. Department of Labor. It does not necessarily reflect the views or policies of the U.S. Department of Labor, nor does mention of trade names, commercial products, or organizations imply endorsement by the U.S. government.

This booklet was produced by K-State Research and Extension, Kansas State University, Manhattan, Kansas.

The information in this publication has been compiled from a variety of sources believed to be reliable and to represent the best current opinion on the subject. However, neither K-State Research and Extension nor its authors guarantee accuracy or completeness of any information contained in this publication, and neither K-State Research and Extension or its authors shall be responsible for any errors, omissions, or damages arising out of the use of this information. Additional safety measures may be required under particular circumstances.

What's Inside?

This booklet teaches important safety practices to follow when using a tractor.

Safety tips, along with real accident reports, have been combined to give you a better understanding of the risks associated with this type of work.

Use this booklet along with hands-on safety training and the equipment operator's manual.

Lesson 1

Objective

1. Define the most commonly reported causes of serious injury and death from tractor accidents.

Take Control of Your Own Safety

Greatest Dangers

Failure to observe safety precautions when operating tractors and attachments can result in serious injury or death. The most common types of serious accidents are:

1. Rollovers

You can be seriously injured or killed if the tractor rolls over.

Accident Report

Employee Killed When Tractor Rolls Over

Summary of OSHA Accident Inspection 112205341660

An employee was using a tractor with a mowing implement. He was not wearing his safety belt. While mowing on a slope, the tractor rolled to the side, pinning him between the rollover protective structure (ROPS) and the ground. He died from his injuries.



Always wear your safety belt; use extra caution when operating on a slope.

2. Runovers

You can be seriously injured or killed if run over by a tractor.

Accident Report

Employee Killed When Run Over By Unmanned Tractor

Summary of OSHA Accident Inspection 111630969140

An employee attempted to jump start a tractor by connecting the battery cables to two other trucks. He was standing in front of the rear tractor tire, and as he turned the starter switch, the tractor moved forward. He was run over.



Start the tractor only while sitting in the operator's seat.

3. Being Caught in Moving Parts

You can be seriously injured or killed if you are caught in the equipment's moving parts.

Accident Report

Employee Killed In Auger Entanglement

Summary of OSHA Accident Inspection 123578858

Several employees were digging holes using a tractor with an attached post hole digger (auger). One employee walked around the digger and his shirt and pant leg became caught on the drive shaft. His leg twisted and was cut off below the knee and he hit his head on the auger's drive line. He was killed.



Keep hands, feet and clothing away from rotating machine parts.

4. Collisions

You can be seriously injured or killed if a collision occurs.

Accident Report

Employee Struck By Branch While Cutting Brush

Summary of OSHA Accident Inspection 304474711

An employee was driving a tractor pulling a mowing implement. He hit a tree branch that entered the cab and struck him in the lower torso. He was killed.



Watch for low hanging tree limbs and other obstructions that could enter the cab of the tractor.

Help Yourself

Safe work habits are important. Here are three actions you can take to be safe on the job site:

1. Learn all you can.

To prevent tractor accidents, read and follow directions in the equipment operator's manual. Pay attention to safety instructions in the manual and warning labels you see on the equipment. If you have questions, stop and ask your supervisor before you continue.

2. Concentrate on working safely.

Sometimes you may be tempted to take risky shortcuts. Remember that an accident can leave you permanently injured or cut your life short. For your safety and the safety of those around you, do not take unnecessary risks. No deadline is so pressing you can't take the time to do your work safely.

3. Additional Precautions.

Do not operate machinery if you are tired or have taken drugs or alcohol. If you are on medication, discuss with your doctor or pharmacist if you are capable of safely operating machinery.

Safety Messages and Signs

Manufacturers put important safety messages on tractors and in the operator's manual. It is critical to read, understand and follow safety messages.

The triangle shape is the symbol for caution. The exclamation mark in the center means *Pay Attention*. In some instances, the triangle-shaped sign will show a picture. Other times, words explain why the sign is used.

Many safety messages use the words *Caution*, *Warning* and *Danger* to get your attention. Each sign has a color assigned to it to get your attention. There are universally accepted colors associated with each sign: caution signs are yellow, warning signs are orange and danger signs are red. Following are safety messages and their meanings. Each of these signs will have a written message, and perhaps a picture, about an unsafe condition.

CAUTION means you need to be careful. Follow the directions on the sign or you could get hurt.



WARNING is more serious and means you need to follow the directions on the sign or you could be badly hurt or killed.

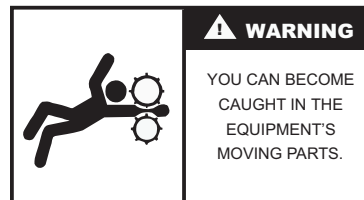

DANGER is the most serious safety message. If you don't follow the directions, you will be seriously injured or killed.



Images displayed in the caution, warning and danger boxes have been recreated from images taken with permission from ASAE S441.4, FEB04, Safety Signs.

Quiz Yourself

Answers can be found on Page 34.

1. What are the most commonly reported causes of serious injury and death from operating tractors? Circle the correct answer.
 - a. Tire blow outs, hydraulic fluid leaks, fire and lightning strikes
 - b. Rollovers, runovers, getting caught in moving parts and collisions
 - c. Carbon monoxide poisoning, heat stroke, burns and being run over

2. Match the safety image with its meaning.

- a. Watch out for a rotating shaft

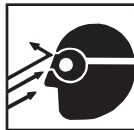

- b. Wear eye protection.



- c. Don't get caught in moving parts.



Lesson 2

Objectives

1. Identify and locate tractor parts to be checked before operation.
2. Discuss steps for safe start-up and shutdown.

Prepare for Safe Operation

Safety starts before the engine. A thorough inspection of the tractor is important before beginning work each day. Use the checklist on the next page as a guide for daily, visual inspections. If you find anything wrong during your daily check, alert your supervisor before starting the tractor.

Daily Pre-operation Checklist:

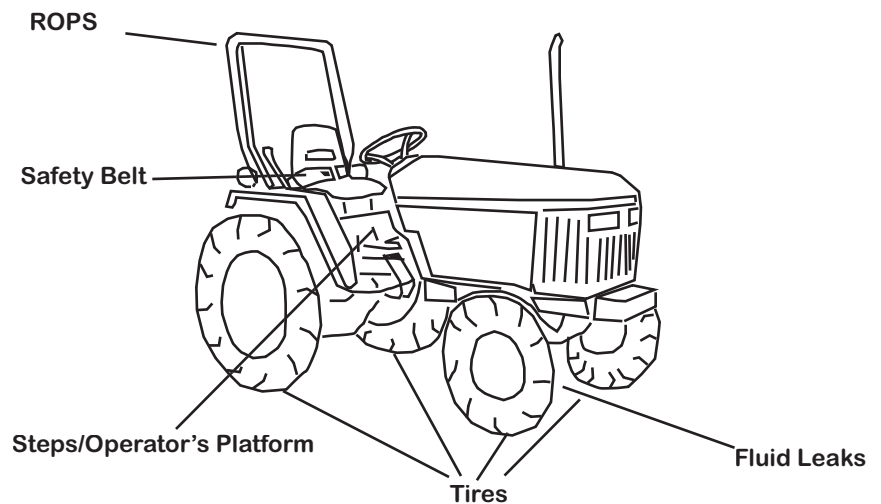

Safety Belt and ROPS

Your safety belt and the tractor's Rollover Protective Structure (ROPS) work together to keep you on the operator's platform if the tractor rolls over. Damage to either of these safety devices can lead to serious injury or death.

Guards and Shields

Safety guards and shields protect you from moving parts. Check the operator's manual for the location of guards and shields. Check for safety decals alerting you to the location of guards. Guards and shields should not be damaged or bent. Report damage to your supervisor immediately.

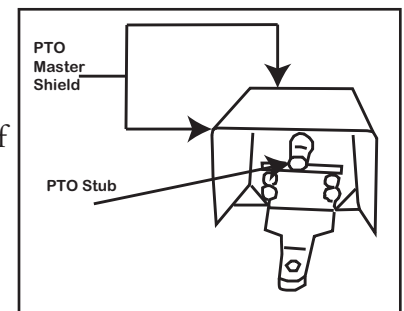

Tires

Proper tire maintenance is important to maintain traction. Tires that show signs of damage, have excessive tread wear or are underinflated will not perform safely.

Steps and Operator's Platform

Slips and falls on steps are a common cause of serious injury. Keep steps and the operator's platform free of ice, mud and debris. When the non-slip step surface becomes worn, it can become slick and should be replaced immediately.

Fluid Leaks

Leaks can cause breakdowns and are possible fire hazards. Puddles or drops of fluid under the tractor indicate a leak. Report signs of leaking fluid to your supervisor immediately.

Fluid Levels

Check the gauge for fuel level, the dipstick for oil level and the radiator for coolant level before you begin each day, while the engine is still cold. Running low on any of these fluids can cause engine failure, and the loss of power may place you in danger.

Safe Start Up and Shut Down

Safe Entry and Start Up

You can be killed or seriously injured if you do not enter or start the tractor correctly. To prevent accidents, follow the instructions in the operator's manual for entry and start up.

- ▶ Clear the area of bystanders before starting the engine, engaging power or moving the tractor.
- ▶ Secure all loose clothing or long hair to prevent entanglement in moving machine parts, and wear sturdy, non-skid shoes to prevent slipping on the operator's platform.
- ▶ If the tractor you are operating produces a lot of noise (see guide, right) wear hearing protection, such as ear muffs or plugs.
- ▶ Fasten your safety belt.
- ▶ Adjust the seat and safety belt so you can reach the pedals, steering wheel and controls.
- ▶ Check to make sure the parking brake is engaged, the transmission is in neutral and all controls are locked.
- ▶ Climb the steps facing the tractor with both hands on the grab bars. This is called a three point technique and is the safest way to enter the tractor.
- ▶ Start the tractor according to the manufacturer's instructions. Allow the tractor to warm up.



Three point technique

Daily Tractor Checklist

- Safety Belt
- ROPS
- Guards & Shields
- Tires
- Steps
- Operator's Platform
- Fluid Leaks
- Fluid Levels

When to Wear Hearing Protection

OSHA Standard 1910.95 (i) (l) requires hearing protection to be worn when sound levels exceed certain limits (generally, a daily average of 85 or 90 decibels, depending on the circumstances). These levels can be measured with a sound level meter. A hearing conservation program requiring hearing tests and other precautions may also be necessary. Check with the equipment operator's manual, as well as your supervisor, for suggestions on hearing protection for each piece of equipment as well as instructions on how to wear it properly.



Hearing Protection Rules of Thumb

Hearing protection may be needed if:

- ▶ You have to raise your voice significantly to be heard by someone three feet away.
- ▶ After leaving a noisy area, your ears feel plugged or you hear a mild ringing or whooshing noise that goes away after an hour or two.
- ▶ When you start your car in the morning, the radio is so loud from the evening before that you have to turn it down.

Tractor Tire Safety

You should inspect tires daily before operation, and pay attention to their condition throughout the workday. Tire maintenance should be performed only by trained, authorized personnel. Consult your operator's manual for correct tire maintenance procedures for your vehicle and tire type.

Practice safe tire maintenance:

Protective Clothing:

- ▶ Follow your company's safety policies regarding the use of protective equipment such as safety goggles, gloves and hard hats while performing tire maintenance.

Tire Pressure:

- ▶ Tire pressure may increase during normal operation and should not be reduced. If you are traveling at higher speeds and experience excessive tire pressure, however, you should lower speed or stop and allow tires to return to normal pressure and temperature before continuing.
- ▶ Do not stand next to a tire while adjusting tire pressure. Stand at a distance, behind the tread, and use a long hose with a snap-on or self-attaching chuck.

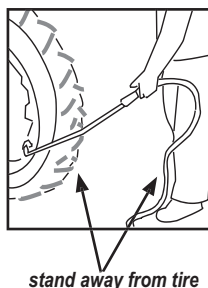

Damaged Tires/Rims:

- ▶ Do not operate a tractor with tires that have low pressure, cracks, damaged rims, cuts, or other damage.
- ▶ Do not weld or cut any part of the rim.
- ▶ Do not reinflate a tire that has been run flat or nearly flat before first inspecting all tire and rim parts for damage.

Support Equipment:

- ▶ Use appropriate jacks, stands and hoists to support the tractor while tires are being serviced.

Returning to Service:

- ▶ When you refill a repaired tire, use a safety cage or restraints.
- ▶ After the tire has been remounted, reinstall covers, guards and shields (if so equipped).
- ▶ Follow manufacturer's torque specifications for fittings, bolts and connections.

Safe Shut Down

Protect yourself from death or injury by following safety procedures during the shutdown process.

- ▶ Bring the tractor to a complete stop and park on a level surface.
- ▶ Lower all attached equipment to the ground.
- ▶ Move controls to neutral, lock controls (if so equipped) and set the parking brake.
- ▶ Make sure the PTO (power take off) is disengaged or off.
- ▶ Allow the tractor to idle down before turning off the engine.
- ▶ Remove the key.
- ▶ Wait for all moving parts to stop.
- ▶ Unbuckle your safety belt and exit by backing down the steps with both hands on the grab bars.
- ▶ Block hydraulic equipment, as necessary.
- ▶ Block the wheels of the tractor and/or attached equipment, if parked on an incline.

Hitching and Unhitching Attachments and Implements

- ▶ Hitch towed loads to the drawbar only.
- ▶ Never raise, lower or otherwise alter the drawbar. Hitching higher than the drawbar can cause a rear rollover.
- ▶ Refer to the operator's manual for instructions on hitching attachments or implements with hydraulics, a 3-point hitch or PTO shaft.
- ▶ Ensure all safety guards are in place and undamaged.
- ▶ Unhitch attachments and implements on level ground only.
- ▶ Keep others out of the area between the tractor and the attachment or implement. They could be easily crushed or caught in the equipment's moving parts.

Safe Fueling Procedures

- ▶ Always shut the engine off before fueling.
- ▶ Always allow the engine to cool before attempting to fuel.
- ▶ Check to make sure you are using the correct fuel for your tractor model.
- ▶ Do not smoke while fueling the tractor.
- ▶ Touch the fuel nozzle to the machine before removing the fuel cap to prevent a static spark from igniting the fuel.

Quiz Yourself

Answers can be found on page 34 and 35.

1. Use the words to label the areas on the tractor that should be checked daily.

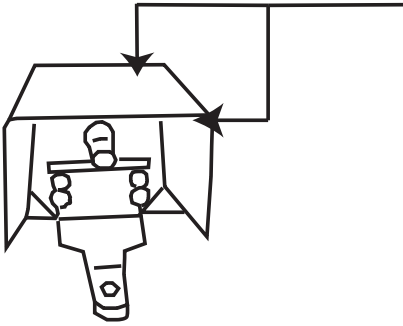

ROPS
PTO Master Shield
Safety Belt
Fluid Leaks
Tires

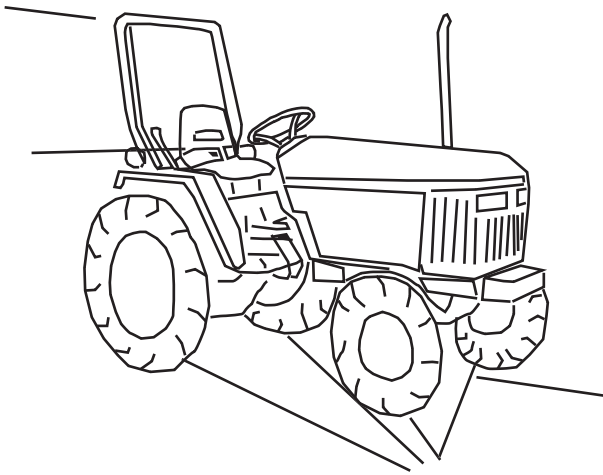

Use the list of words to fill in the blanks of the safe start up procedures.

facing
operator's seat
safety belt

2. Climb the steps _____ the tractor with both hands on the grab bars.
3. Never start a tractor from anywhere other than the _____.
4. Adjust the seat so your hands and feet can reach all controls and the steering wheel with the _____ fastened.

Lesson 3

Objectives

1. Identify safe work procedures to prevent rollover accidents.
2. Evaluate safe operating procedures for hills and slopes.

Avoiding Rollover Accidents

Rollover accidents often result in serious injury or death. The three types of tractor rollovers are to the side, rear and front.

Rollovers occur when a tractor becomes unbalanced. Some of the most common causes are:

- ▶ Overloading
- ▶ Carrying loads too high
- ▶ Improper hitching
- ▶ Operating on bumpy or uneven surfaces
- ▶ Popping the clutch
- ▶ Applying brakes unevenly
- ▶ Operating too close to drop offs
- ▶ Driving too fast

Human reaction time is too slow to stop a rollover once it starts. You can avoid rollovers by recognizing dangerous situations and taking action to avoid them.

1. Side rollovers

Side rollovers are the most common type of rollover accident. They occur when the tractor becomes unbalanced, often while it is being driven across a hill, carrying a load too high, or traveling too fast across uneven ground.

Accident Report

Employee Killed When Tractor Rolls Over

Summary of OSHA Accident Inspection 120060140

An employee drove a tractor too close to the side of a steep embankment, causing it to roll down the hill. The tractor came to rest almost upside down. The employee was not wearing the safety belt and his head struck against the rollover protective structure (ROPS). He died from head injuries sustained in the accident.



***Stay away from steep embankments;
never operate a tractor without wearing a safety belt.***

2. Rear Rollovers

Rear rollovers can occur when a tractor is towing a load that is too heavy or not properly balanced, when driving uphill, or when using an attachment or implement.

Accident Report

Employee Killed While Towing With Tractor

Summary of OSHA Accident Inspection 0950621

An employee was using a tractor to pull a truck out of the mud. The employee attached a chain between the back of the tractor and the truck and attempted to pull the truck with the tractor. The weight of the truck caused the tractor's front to rise off the ground and roll over backward, landing on top of the employee. His neck was broken and he died at the scene.



Do not attempt to pull loads that are greater than the tractor's towing capacity.

3. Front Rollovers

Front rollovers occur most often when an operator fails to stop before a dropoff, or accidentally drives over an embankment.

Accident Report

Employee Killed When Tractor Falls Over Ledge

Summary of OSHA Accident Inspection 125470765

An employee was operating a tractor equipped with a blade attachment. He drove up a ramp which was surrounded by a guard rail. The tractor went through the guard rail and flipped forward over the edge of the ramp. The employee was crushed and killed by the tractor.



Avoid operating a tractor close to ledges; keep away from guard rails.

How to Avoid Rollover Accidents

- ▶ Drive slowly. When speed is increased, the risk of a rollover also increases.
- ▶ Operate controls smoothly. Avoid jerky starts, turns and stops that cause the tractor to become unstable.
- ▶ Reduce speed when turning, crossing slopes or when traveling on rough, slick or muddy surfaces.
- ▶ Avoid running over obstacles that can cause the tractor to tip over.
- ▶ Don't overload the tractor or attachments. Check the capacity label or data plate for maximum load limit. Don't go over that limit or the tractor may become unstable and roll over.
- ▶ Consult your owner's manual for proper counter weight usage.
- ▶ When you must operate on a slope, keep the heavy end of the tractor facing uphill.

Understanding ROPS

Rollover protective structures (ROPS) have been required by law since 1976. However, many tractors built before 1976 are still in use. ROPS are protective frames securely attached to a tractor to prevent the operator from being crushed if the tractor overturns. ROPS will not prevent rollover accidents; however, it will help protect you if a rollover accident occurs.

Not all cab or operator covering structures are ROPS. For example, an awning to protect the operator from the sun is not an approved ROPS structure and provides no protection in a rollover. Certified ROPS must meet strict engineering performance standards. They must support the weight of the tractor and create a protective zone for the operator during a rollover. Typically, ROPS limit overturns to 90 degrees.

Approved ROPS can be:

- 1) an enclosed cab with the cab frame serving as ROPS
- 2) an open station four-post ROPS
- 3) an open station two-post ROPS
- 4) a two-post ROPS that folds or telescopes for low clearance.

Carefully check the operator's manual to learn if the tractor you are operating is equipped with an approved ROPS.

When operating a tractor with ROPS **always** use your seat belt. If you do not wear your seat belt, ROPS may not protect you from being crushed in a rollover accident.

Safe Hill Operation

Tractors are designed to operate on hills with a grade of 20 percent or less. You can be seriously injured or killed if you operate on a hill with a grade steeper than 20 percent.

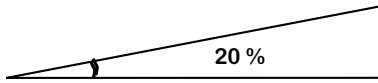

Never drive across a hill while operating a tractor. The tractor could become unstable, causing a side rollover.

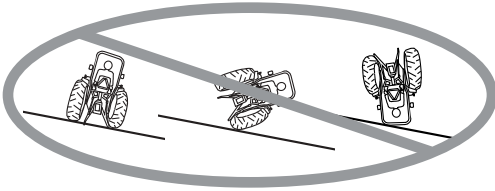

Never drive with the heavy end of the tractor facing down hill. A rear rollover could result.

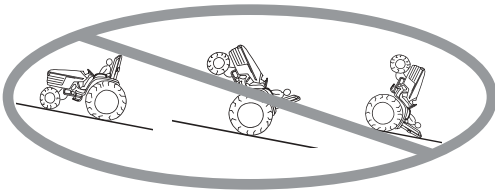

Always drive up and down the face of the hill with the heaviest part of the tractor facing uphill. With no attachments, a tractor's heavy end is the rear.

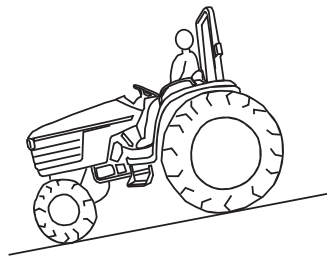

When operating with a front attachment, drive forward up a hill.

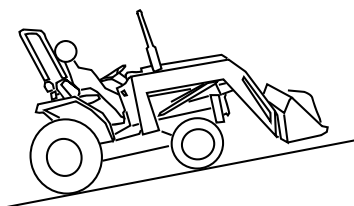

- ▶ When operating with a bucket attachment, carry loads as low to the ground as possible, while still clearing the ground.
- ▶ Avoid ditches, embankments, holes and any slope that is too steep for safe operation.
- ▶ Distribute loads evenly in a bucket attachment. Side overturns are possible if the load is uneven and the bucket is carried too high.
- ▶ Secure unstable loads so they won't shift or fall causing the tractor to roll over.
- ▶ Hitch only to the tractor's drawbar. Drawbars are designed to provide maximum pull for towed loads. When you hitch anywhere other than the drawbar, the tractor may tip backward during operation. Keep the hitch low when using a 3-point hitch drawbar.
- ▶ Do not drive forward if the tractor is stuck in the mud. Always back out. If you cannot back out safely, tow the tractor with another vehicle.

Reaction Time

Reaction time is the time it takes for a person to react to an event or an emergency. A tractor can tip over in $\frac{3}{4}$ of one second; much faster than human reaction time.

Many factors can affect your reaction time such as:

- ▶ Inexperience
- ▶ Age
- ▶ Fitness level
- ▶ Fatigue
- ▶ Illness
- ▶ Preoccupation/distraction
- ▶ Mood
- ▶ Weather
- ▶ Alcohol, tobacco, drug or medication use
- ▶ Poor vision
- ▶ Poor hearing
- ▶ Machine vibration

Recognize these factors and how they affect your ability to react to a potentially dangerous situation.

Quiz Yourself

Answers can be found on page 35.

Circle the correct answer to complete the sentence.

1. The most common type of rollovers are _____
_____.
 - a. side rollovers.
 - b. forward rollovers.
 - c. rear rollovers.
2. Keep the heavy end of the tractor facing _____ when you must operate on a slope.
 - a. up the hill
 - b. down the hill
3. When tractor speed increases, it is _____ likely to rollover.
 - a. less
 - b. more
4. Circle the correct way for a tractor to operate on a hill.

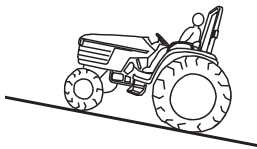
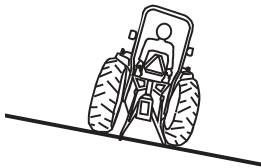
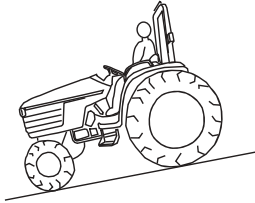

Lesson 4

Objectives

1. Discuss types and causes of runover and collision accidents.
2. Identify correct operating procedures for avoiding runover and collision accidents.

Avoiding Runover and Collision Accidents

You can be killed or seriously injured if you are run over by a tractor or collide with another object while driving the tractor.

Runover accidents often occur when:

- ▶ The operator is run over while attempting to start the tractor or use the controls while not in the operator's seat
- ▶ The operator is knocked out of the seat by an obstacle (such as a low-hanging tree branch)
- ▶ The operator falls out of the seat when the tractor hits an obstacle (such as a tree stump or boulder)
- ▶ A passenger (extra rider) falls off the tractor
- ▶ A bystander near the tractor is run over

Collisions can occur between the tractor and an unseen object such as a hidden tree stump or rock, or a low-hanging branch or structure. Collisions can cause serious injury or death when:

- ▶ The operator is struck by an obstacle
- ▶ The tractor collides with an obstacle and the operator is thrown from the tractor
- ▶ The tractor collides with an obstacle and then rolls over

Operator Runovers and Collisions

The safest place for the operator of a tractor is in the operator's seat, with the safety belt buckled. You can be seriously injured or killed if you attempt to operate a tractor from the ground or another location on the tractor.

- ▶ Never leave the operator's platform with the engine running.
- ▶ Never start a tractor by shorting across the starter terminals. If the tractor is in gear, it will lurch into motion and run over you.
- ▶ When performing maintenance, make sure to block all hydraulic attachments, place controls in neutral and use approved jacks and hoists.

Accident Report

Employee Killed When Run Over by Tractor Mower

Summary of OSHA Accident Inspection 0111700

An employee was using a tractor with a mowing attachment when the right front wheel of the tractor apparently struck an obstacle. The employee was thrown from the tractor and then run over by it. He was killed. The tractor was missing half the safety belt.



***Be careful to not run over obstacles;
never operate a tractor with a broken safety belt.***

Accident Report

Employee Killed When Run Over By Tractor

Summary of OSHA Accident Inspection 0418800

An employee who was operating a tractor stopped, put the tractor in neutral, but did not turn off the engine or set the emergency brake before exiting. The tractor began to roll down an incline, and the employee attempted to mount the moving tractor and was run over by the rear wheel and killed.



Always follow safe shut down procedures before exiting the tractor; never mount a moving tractor.

Accident Report

Maintenance Worker Run Over by Tractor

Summary of OSHA Accident Inspection 170843064

An employee was repairing a broken flail mower attachment on a tractor. He was standing in front of the left rear wheel, welding the broken support back together when he reached across to the hydraulic controls and accidentally engaged the transmission. The tractor drive wheel ran over his chest and crushed him. He was killed. The transmission was not in neutral and the brakes were not set.



Follow safe shutdown procedures before performing maintenance on the tractor.

Bystander Runovers and Collisions

Coworkers, maintenance personnel and other bystanders can be seriously injured or killed if safe operating procedures are not followed.

- ▶ Check around the tractor before starting or moving.
- ▶ Keep bystanders and coworkers at a safe distance while you operate the tractor.
- ▶ If an attachment or implement is blocking your view, shut down and walk around the tractor to make sure no one is in the area.
- ▶ Never let anyone stand between the tractor and an attachment or implement. They could be run over by the tractor or crushed between the tractor and attachment or implement.
- ▶ If a coworker is helping you guide the tractor, make sure they are far enough away from the vehicle to not be run over.

Guide Safety

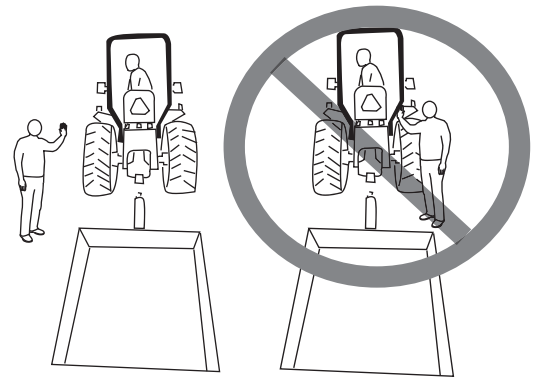

SAFE GUIDE:
The guide is out of the way of the tractor and attached equipment. The operator can drive without endangering the guide.

UNSAFE GUIDE:
The guide is between the tractor and attached equipment, and could be seriously injured or killed if the tractor begins to move.

No Extra Riders!

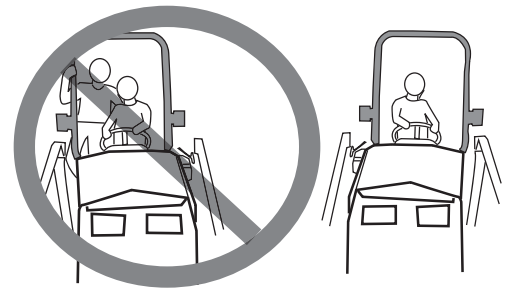

Never allow anyone to ride on a tractor unless in an approved passenger carrier.

There is not a safe place on the tractor for anyone other than the driver.



Watch for Collision Hazards

Check your work area for hidden obstacles such as: rocks, hidden machinery or a tree stump in tall grass.

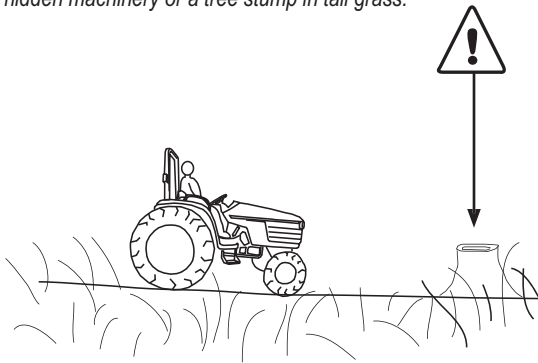

When driving, make sure you are clear of any low hanging branches, power lines, or structures.

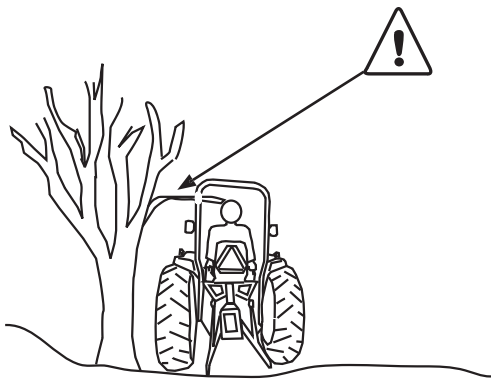

Even though the tractor may fit, double check to make sure attached equipment clears posts, doorways and other obstacles.

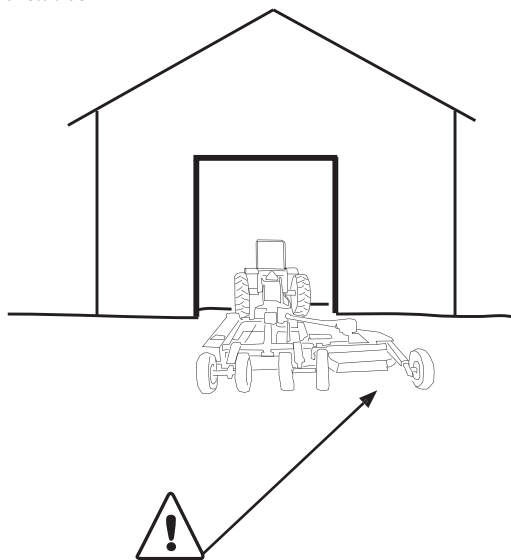

Passenger Runovers and Collisions

Anyone who is not in the driver's seat of the tractor is in danger of falling and being run over. Human reaction time is too slow for a driver to react if a passenger falls off the tractor.

- ▶ Never allow extra riders on a tractor.
- ▶ Do not allow anyone to ride or stand on the draw bar, axle housing, side links of a three-point hitch, rear wheel fenders or attachments.
- ▶ Do not allow passengers on the operator's lap.
- ▶ Use only approved passenger attachments.

Be Aware of Obstacles

When operating a tractor without a cab, you can be crushed or thrown out of the driver's seat if you hit an obstacle or rough surface.

- ▶ Always wear your safety belt.
- ▶ Check the work area before you begin. Note all potential obstacles: low hanging tree branches, rocks, pipes and low hanging wires. Make sure you have adequate clearance through narrow passages, doorways and other openings.
- ▶ Maintain a clear line of sight. Keep the windows and mirrors clean and in good repair. Keep attachments low to the ground so you can see over them.
- ▶ Use a guide to direct your path when an attachment or implement blocks your view.

Safe Backing Procedures

Before backing a tractor, make sure the area is clear of people and obstacles.

- ▶ Make sure the seat and all controls are properly adjusted. Drivers often shift slightly as they turn in the seat to reverse, causing feet or hands to lose contact with the controls.
- ▶ When an implement blocks your view, ask a coworker to guide you. Keep the guide in your line of sight, but far enough away that he or she cannot be run over.
- ▶ Consult the tractor, attachment and implement owner's manuals for proper backing techniques.

Quiz Yourself

Answers can be found on page 36.

For each pair of drawings, circle the one that shows the operator using safe procedures.

1.

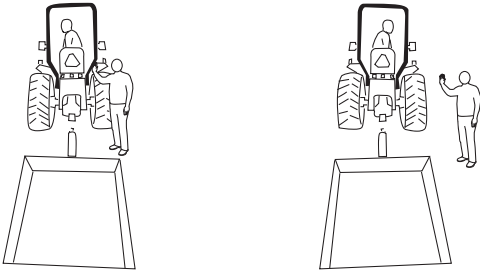

2.

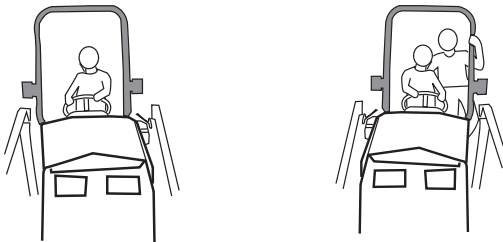

3. Use words from the list to complete the sentences.

operator's seat

moving

branches

- a. Never attempt to mount a _____ tractor.
- b. When driving, make sure you are clear of any low hanging _____, power lines or structures.
- c. Never start a tractor from anywhere but the _____.

Lesson 5

Objectives

1. Identify mechanical tractor and implement hazards.
2. Describe how to avoid injury from moving machine parts.

Moving Parts and Machinery Hazards

You can be seriously injured or killed if you or your clothing become caught in a tractor's moving parts. Entanglements happen in power driven shafts, belts, gears, chains or wheels.

Accident Report

Employee Injured In Drive Shaft Of Post Hole Digger

Summary of OSHA Accident Inspection 119581437

An employee was using a tractor with an attached post hole digger. As the hydraulically controlled auger was being lowered, he used his body weight to push down on the post hole digger. His clothes became caught, entangling him in the driveline shaft and support boom. He was seriously injured. An investigation showed that guards had been removed from the digger that would have protected the employee.



Never operate equipment with missing guards or shields.

The Power Take Off (PTO)

One of the most dangerous power transfer devices on a tractor is the PTO. Maintaining proper machine guards can lower injury risk. A PTO stub rotates either at 540 revolutions per minute (rpm) or 1,000 rpm. You are protected from the rotating stub by the PTO master shield and from the rotating shaft by the PTO integral shield. Report a missing or damaged shield to your supervisor and do not operate the tractor until the shield has been replaced or repaired. The

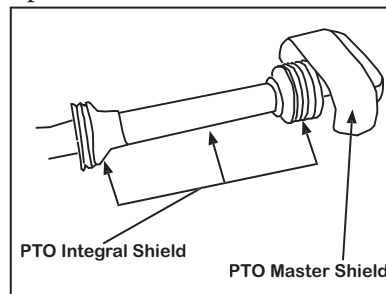

following safety practices can help prevent the most common types of PTO entanglements:

- ▶ Follow safe shutdown procedures and wait for all moving parts to stop, before dismantling the tractor.
- ▶ Keep all parts of the PTO system shielded and guarded.
- ▶ Periodically check driveline guards by spinning or rotating them to make sure they haven't become stuck to the shaft.
CAUTION: *This should only be done with the engine off.*
- ▶ Never step over a rotating PTO shaft.
- ▶ Make sure the PTO speed matches the implement's recommended speed.
- ▶ Never wear loose fitting clothing near a rotating PTO. Make sure shoe laces are tied and secure long hair.

Other Mechanical Hazards

The tractor industry has grouped mechanical hazards into categories: pinch points, wrap points, shear points, crush points, burn points, freewheeling parts, stored energy and thrown objects. Following are eight examples of mechanical hazards with their corresponding warning symbols.

Pinch points are formed when two machine parts move together and at least one of the parts moves in a circle. Examples of pinch points are gear, belt or chain drives. Keep guards and shields in place to protect yourself from pinching injuries.



Wrap points occur when any part of the machine rotates. Loose clothing or hair can easily be caught in rotating mechanical parts. The rotating PTO is one of the most common wrap points. Maintain guards to protect yourself from rotating wrap points. Make sure your shoe laces are tied, and never wear loose fitting clothing.



Shear points occur when the edges of two machine parts move across or close to each other to create a scissors-like area that can cut through skin, clothing and body parts. One of the objects can be stationary or both can be moving.



Hedge trimmers are an example of a machine with a shear point. To prevent shearing injuries, shut off the machine before working on it.

Crush points are formed when two objects are moving toward each other or when one object is moving toward a stationary object and the gap between them is getting smaller. The most common example of a crush point is a tractor backing up to be attached to an implement. Do not allow someone to stand between the tractor and an implement while hitching.



Burn points occur where machine parts get hot. Mufflers, engine blocks, pipes and hydraulic fluid couplers are examples of burn points. Avoid burns by not touching the engine or machine parts.



Freewheeling parts continue to move after power to the machine has been turned off. This happens because of the large amount of force required to move mechanical parts. Bringing this force to an immediate stop is almost impossible. To avoid injury from freewheeling parts, stop the tractor engine, disengage the PTO and wait for the machine to stop completely before inspecting



Stored energy is energy that has been confined and is released unexpectedly. Springs and hydraulic systems are examples of potential stored energy. To avoid stored energy hazards, know which parts of the machine are spring loaded. Relieve hydraulic pressure when you shut down each day.



Keep Clear of a Rotating PTO

A 3" diameter PTO rotating at 540 rpm will wrap at 7 feet per second. How fast can you react?

Reaction Time	PTO will wrap...
1/4 of a second	21 inches <i>about the length of your shoulder to your fist</i>
1/2 of a second	42 inches <i>about the length of your leg</i>
3/4 of a second	64 inches <i>about the height of an average person</i>
1 second	85 inches <i>about the height of a doorway</i>

Images used in the "Other Mechanical Hazards" section have been recreated from images taken with permission from ASAE S441.4, FEB04, Safety Signs.

! If the tractor or attached equipment contacts an electric power source:

1. Remain calm.
2. Follow safe shutdown procedures.
3. Stay in your seat or you could be electrocuted.
4. Get someone to call the power company.
5. Keep people away from the machine and its attachment(s).
6. Wait until the power has been disconnected before getting off the tractor.

Hydraulics Hazards

Hydraulics systems can fail without warning. Do not allow anyone to stand below a raised hydraulic device without proper blocking.

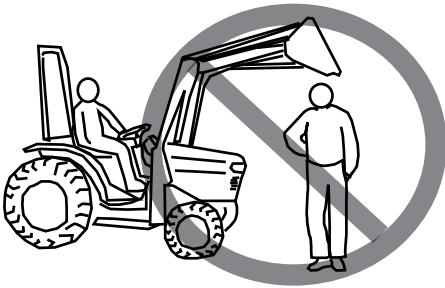

Hydraulic injection injuries are serious:

Leaks in hydraulic hoses form a thin, high-pressure stream that quickly slices through skin, causing a serious injury called a hydraulic fluid injection.

Seek medical attention immediately! A hydraulic fluid injection injury is serious, even if it does not cause a great deal of pain.

Thrown objects are materials that are discharged from the machine.



These hazards can be caused by rotating fan or knife blades used to cut, grind or chop materials, such as a rotary mower. Avoid thrown object injuries by allowing the machine to come to a complete stop before approaching the discharge area. Keep the discharge chute pointed away from bystanders. Wear eye protection to protect yourself from thrown objects. When using a rotary mower attachment, consult your owners manual regarding proper shielding to protect the operator.

Electrical Hazards

When a tractor or attached implement comes into contact with electricity you can be electrocuted. Talk with your supervisor before starting a job that requires work near an electric power source.

- ▶ Call your state's one-call utility location hotline to identify buried lines before digging. The phone number will be in the information pages in the front of the phone book.
- ▶ Don't carry tall loads near electric power lines.
- ▶ Keep attachments as low as possible when working near overhead lines.
- ▶ Never drive over downed or exposed power lines.

High Pressure Hydraulics

Another way power is transferred from a tractor to an attachment is through hydraulics.

- ▶ Be aware that a hydraulics system can fail without warning. Never stand or work under equipment that has been raised unless it is supported by an approved lift support device. Check the tractor and equipment operator's manuals for information on approved support devices.
- ▶ Keep the ends of the hoses and connections free of dirt and dust.
- ▶ Never use your hand to check hydraulic hoses for leaks. When you suspect a leak, have a qualified person check for leaks.
- ▶ Check for heat before disconnecting hydraulic hoses.

Quiz Yourself

Answers can be found on page 37.

Use the list of words to fill in the blanks of the following sentences.

PTO system

toward

entanglements

medical attention

1. _____ happen when you or a piece of your clothing becomes caught in moving equipment parts.
2. Crush points are formed when two objects are moving toward each other or when one object is moving _____ a stationary object and the gap between them is getting smaller.
3. Keep all parts of the _____ shielded and guarded.
4. Seek immediate _____ if you suffer a hydraulic fluid injection injury.
5. Draw a line from the word to the part it describes.

PTO master shield

PTO integral shield

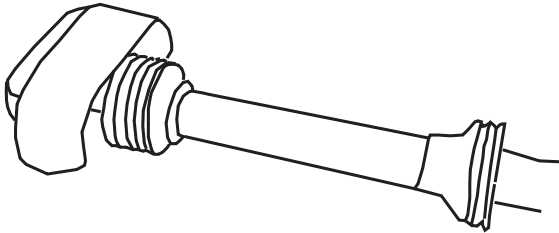

Lesson 6

Objectives

1. Identify safe operating procedures when driving a tractor on the highway.
2. Explain other health and safety risks associated with operating a tractor.

Highway Safety and Other Hazards

You may be required to move a tractor from one location to another using a public roadway, or you may be required to work near a public roadway. You can be seriously injured or killed if the tractor you are operating is involved in an accident. Since a tractor driver may not be able to hear over engine noise, he or she has to depend on sight alone to be aware of the surroundings. When you must operate a tractor on a public road, remember to obey all traffic laws and signs.

Accident Report

Employee Killed When Tractor Flips Over on Public Road

Summary of OSHA Accident Inspection 300256138

An employee was traveling on a public highway in a tractor pulling a loaded trailer. He was driving downhill too fast and the tractor began to sway. As he attempted to turn left onto the employer's property, the trailer swayed, causing the tractor to flip over. The employee, who was not wearing a safety belt, was thrown from the tractor and crushed to death when it rolled on top of him.



Refer to the tractor operator's manual for safe highway speed for your model of tractor and attachments.

Tips for Safe Highway Travel

- ▶ Obey all traffic laws and signs.
- ▶ Avoid driving the tractor on public roads during rush hours.
- ▶ Always be aware of what is going on around you. Remember, a tractor is difficult to maneuver, so you will not be able react quickly to avoid an accident.
- ▶ Allow faster traffic to go around you when possible.
- ▶ Use an SMV (Slow Moving Vehicle) emblem to identify the tractor as a vehicle that travels 25 mph or less. When towing equipment, the SMV emblem should be visible on the back of the equipment.
- ▶ If the vehicle is equipped with right and left brake pedals, lock them together for traveling on the road. If brake pedals are not locked together, hitting one brake at road speed may cause the tractor to turn suddenly.
- ▶ Maintain a safe following distance. Because of the size and weight of the tractor, it will take you more space to stop than a normal passenger vehicle.
- ▶ Make sure your equipment does not come close to other lanes.



- ▶ Avoid driving at night, when possible. When you must drive at night, use appropriate lights and reflectors.

Towing Attachments and Implement

- ▶ Fasten equipment only to the tractor's appropriate draw bar with the correct hitch pin.
- ▶ Supplement the hitch with a safety chain for highway travel. The safety chain must be strong enough to hold the tractor and attachment or towed vehicle together if the primary hitch fails.
- ▶ Lock all towed equipment in the transport position.

Working Safely Near Traffic

- ▶ When working near a public roadway, use a flagger and warning cones to alert oncoming traffic. Locate flaggers and cones far enough ahead of the work site so drivers have time to slow down.
- ▶ The tractor operator and the flagger should wear highly visible, reflective clothing.
- ▶ Do not park the tractor on a public roadway. When you must leave the tractor at a work site, find a level surface, away from the road, and follow safe shut down procedures.

Health and Environmental Hazards

Heat Stress

You can become seriously ill or die if you do not take proper precautions while working outdoors in high temperature and/or humidity. Heat can reduce physical performance, as well as mental alertness, which can cause serious accidents.

Accident Report

Employee Collapses From Heat Stroke, Dies in Grass Fire

Summary of OSHA Accident Inspection 0950624

An employee was using a tractor to mow grass. Witnesses saw the employee standing behind the tractor at the roadside with his shirt removed, while a slowly-moving grass fire was seen ahead of the tractor. The body of the employee was found on the ground later, severely burned. Investigation revealed that the employee had collapsed due to heat stroke and then the fire passed over him and killed him.



Drink plenty of fluid, and seek assistance at the first sign of heat stress.

Be Careful on the Road

When traveling on a public roadway, make sure to leave enough room for motorists to get around your vehicle and attachments.

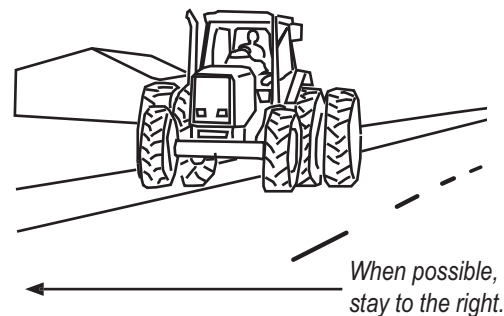

Use a transport trailer to move the tractor between job sites instead of driving on a public road, whenever possible.

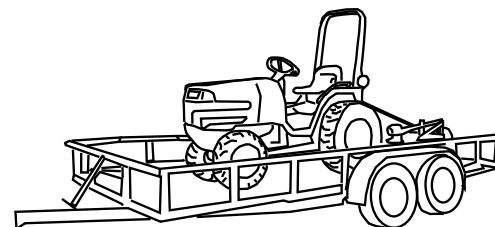

Heat Illness Symptoms

Heat Exhaustion

Heat exhaustion is a serious illness and needs to be treated immediately before a heat stroke occurs. If you or a coworker experience any of the following symptoms, cool off immediately and drink plenty of water.

- ▶ Dizziness
- ▶ Light headedness
- ▶ Headache
- ▶ Feeling weak, fatigued
- ▶ Clammy and moist skin

Heat Stroke

Heat stroke is a medical emergency that can become fatal. If anyone experiences the following symptoms of heat stroke, call 911 immediately.

- ▶ Hot, dry, red skin (not sweaty)
- ▶ Disorientation
- ▶ Confusion
- ▶ Body temperature greater than 105°F
- ▶ Convulsing
- ▶ Unconsciousness

Heat illness starts with heat exhaustion, and if not given proper attention, can lead to heat stroke. Take action immediately if you notice anyone with symptoms of heat illness (shown, left).

Avoid Heat Related Illnesses

To help prevent a heat related illness:

- ▶ Drink water often throughout the day; don't wait until you're thirsty to get a drink. At least a quart of water per hour is recommended.
- ▶ Stay away from soda, coffee, tea and alcoholic drinks that dehydrate the body.
- ▶ Avoid large meals before working in the heat.
- ▶ Some prescriptions can make you more susceptible to heat illnesses. Check with your doctor or pharmacist to see if any medicine you are taking could affect you while working in the heat.
- ▶ Wear light-weight fabric, such as cotton, to help control body temperature.
- ▶ Wear a hat or sun visor on sunny days to help control body temperature.
- ▶ Plan to do the heaviest work at the coolest part of the day. This is usually between 6 a.m. and 10 a.m.
- ▶ Take frequent, short breaks in shaded areas to cool down.
- ▶ Do not take salt tablets, unless recommended by your doctor. Most people receive enough salt in their diet to account for the salt that is lost through sweating.

In Case of Heat Illness:

- ▶ If someone feels overheated, move them to a cooler, preferably air conditioned area. Watch the person and seek medical attention if needed.
- ▶ Fan the person to increase cooling.
- ▶ Have the person drink plenty of fluids.
- ▶ If the person goes into convulsions or shows symptoms of heat stroke, soak their clothes with cool water and call for help immediately.

Heat Facts

- ▶ You are more likely to suffer from a heat related illness on humid days.
- ▶ If you are not used to working in the heat, you are more likely to suffer from a heat related illness. It can take your body anywhere from 5 days to 2 weeks to be acclimated to working in the heat. It is recommended that you start out by working half of the normal time and workload on the first day then build up to a complete day by the end of the week.
- ▶ You are more vulnerable to heat illness if you have suffered from it in the past.
- ▶ During the course of the day, you can produce as much as two to three gallons of sweat. Replenish this fluid by drinking

liquids so that you do not suffer from a heat related illness.

Sun Exposure

Prolonged exposure to sunlight causes skin cancer, cataracts and other serious illnesses.

- ▶ Choose a sunscreen that is marked broad-spectrum. This will protect you from both UVA and UVB rays. Ensure the Sun Protection Factor (SPF) is at least 15.
- ▶ Wear a hat or sun visor, sunglasses, and lightweight long-sleeve shirts and pants on sunny days to help control body temperature and block the sun.

Lightning Precautions

Lightning strikes injure and kill hundreds of people each year. Follow these precautions to help keep you safe when the weather turns bad.

- ▶ As soon as you hear thunder, shut off your tractor and move indoors. When you are able to hear thunder, you can be struck by lightning. Lightning can strike even when it's not raining.
- ▶ The cab of an enclosed vehicle provides some protection from lightning but a sturdy building provides the best protection.
- ▶ Listen to the radio for weather updates and storm warnings.

If You Can't Take Cover Inside:

- ▶ Get to a low place. Lightning strikes the tallest objects.
- ▶ Crouch down on the balls of your feet. Place your hands on your knees and lower your head between your knees.
- ▶ Minimize contact with the ground.
- ▶ Do not lie flat on the ground; this will make you a larger target.

Keep away from:

- ▶ Large, lone trees and towers, fences, telephone poles and power lines
- ▶ Rivers, lakes, swimming pools, and other bodies of water
- ▶ Metal objects, tools, equipment, wire fences and umbrellas.

Carbon Monoxide

Carbon monoxide (CO) is a colorless, odorless, tasteless gas that can poison and kill. Symptoms of CO poisoning include headache, nausea, weakness, dizziness and the loss of consciousness. To avoid CO poisoning, operate all equipment outdoors. If you must operate a tractor indoors, make sure there is adequate ventilation to prevent exposure to CO.

Lightning Safety

When weather turns bad, take cover indoors. Never park your tractor near a tree for shelter.

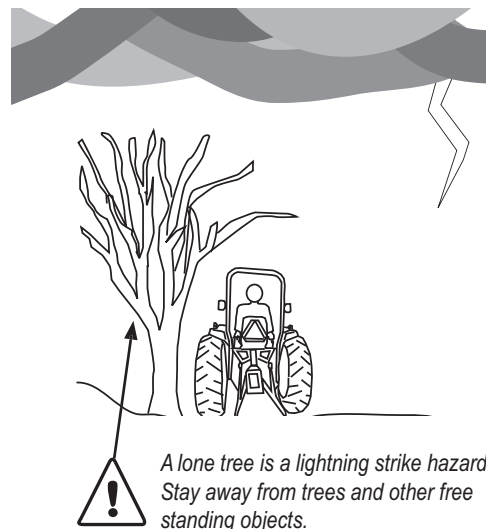

A lone tree is a lightning strike hazard. Stay away from trees and other free standing objects.

If Someone is Struck by Lightning

- ▶ Call 911
- ▶ Check to see if they're breathing. Rescue Breathing or CPR may be required.
- ▶ Check for burns on their body.
- ▶ Move the victim inside, out of the storm.

With immediate treatment, most lightning-strike victims survive.

Cold Induced Injuries and Illnesses

Prolonged exposure to freezing temperatures can result in cold-induced injuries and illnesses that can seriously injure or kill you.

Cold temperatures reduce mental alertness and cause fatigue and exhaustion that can lead to accidents.

Frostbite

Frostbite occurs when parts of the body become so cold that the skin and tissue freezes. Frostbite normally occurs on ears, nose, fingers, hands, toes and feet or other parts of the body that are left uncovered in below-freezing temperatures. Frostbitten skin becomes numb and turns a pale white color.

Hypothermia

Hypothermia occurs when a person's body temperature drops to or below 95° F. Common symptoms include bluish-colored skin, uncontrollable shivering and drowsiness or fatigue.

Avoid Cold-Induced Injuries and Illnesses

- ▶ Layer clothing when working in cold temperatures; you can easily take off layers if you are too warm.
- ▶ Wear a hat and gloves.
- ▶ Keep muscles warm and loose by moving as much as possible.
- ▶ Take frequent, short breaks in warm areas.
- ▶ Perform work at the warmest part of the day, typically in the afternoon.
- ▶ Never work alone.

Insect Stings

Insect stings can be treated without medical attention unless the person suffers an allergic reaction.

The first step to treating an insect sting is to remove the stinger. This can be done by using a straight edge to scrape off the stinger or by using tweezers to pull it out. If you choose to use tweezers to remove the stinger, use extreme caution to not puncture the protruding venom sac.

After the stinger has been removed, a cold pack can be used during the first 24 hours to suppress pain and swelling. Following the first 24 hours, heat should be applied if pain or swelling persist.

Those with severe allergies to insect stings should consult a physician about carrying a prescription medical kit. The kit contains medicine and instructions to be used if the person is stung. If the kit is used, the victim still must receive medical attention. Call for help or take them to the nearest hospital.

Snake Bites

If you are bitten by a snake, seek medical attention immediately and try to describe the size and color of the snake to the doctor. This can help the doctor determine whether or not the snake was poisonous.

Never cut, suck or apply cold packs to snake bites.

Mammals

Be aware of animals such as squirrels or bats that may be in trees or bushes and startle you during work. Also, be cautious of animals such as rats, skunks and raccoons that could be rabid.

Poison Ivy, Oak and Sumac

- ▶ Wash the affected area and all clothing and tools that may have touched the plant.
- ▶ Avoid scratching the area if possible, to prevent infection.
- ▶ Hot and cold compresses can be used to suppress itching.
- ▶ Consult a doctor if the rash is on the face, inside the mouth or covers a large portion of the body.

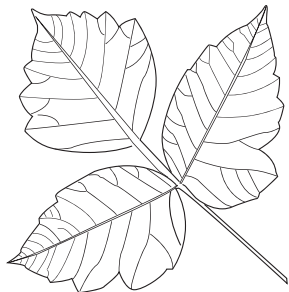

Poison Ivy
Leaves are usually
found in clusters of three.

Treating Cuts and Burns

Minor cuts and burns can be treated on the job site.

Seek medical attention if:

- ▶ Cuts are severely bleeding, more than one-half inch long and one-quarter inch deep, or the result of a puncture wound.
- ▶ Burn area covers more than one-fifth of the body with blisters, blisters occur on the hands, feet, face or genitalia, or if the skin is blackened or charred.
- ▶ A cut or burn becomes infected.

Treating Cuts

- ▶ Clean the area thoroughly.
- ▶ Remove any debris that may be in the wound.
- ▶ Apply pressure to the wound using gauze or a clean, absorbent cloth until the bleeding stops. If blood seeps through the cloth, do not remove it, continue adding more gauze or cloth over the previous one.
- ▶ Apply an antibiotic ointment and cover with a bandage or clean gauze.
- ▶ Allow wound to heal and keep dirt from creating infection by changing the bandage or gauze frequently.
- ▶ If a limb has been amputated, elevate while applying direct pressure and call 911.

Treating Burns

- ▶ Cool the burn by placing it under cool running water or in a container of cool water for at least 15 minutes.
- ▶ Cover the area with gauze or a clean cloth.
- ▶ Allow burn to heal and keep dirt from creating infection by changing the gauze frequently.
- ▶ If blisters occur, do not break them. Cover with gauze and allow them to break on their own.

First Aid Kit Contents

The following is a list of minimum requirements for workplace first aid kits as outlined by ANSI Standard Z308.1-2003*.

- ▶ absorbent compress
- ▶ adhesive bandages
- ▶ adhesive tape
- ▶ individual-use antiseptic applications
- ▶ individual-use burn treatment applications
- ▶ latex-free medical exam gloves
- ▶ sterile pads
- ▶ triangular bandage

*ANSI Z308.1-2003 is published by the International Safety Equipment Association, Arlington, VA www.safetysiteequipment.org. Used with permission.

Quiz Yourself

Answers can be found on pages 37 and 38.

Use the list of words to complete the following sentences.

pulling
aware
laws
brake pedals
thunder

- Obey all traffic _____ and signs when operating a tractor on a public roadway.
- Lock _____ together for road travel.
- Always be _____ of what is going on around you when you are driving a tractor.
- Lock all towed equipment in the transport position before _____ it on the road.
- Seek shelter at the first sound of _____, which means there could be lightning strikes in the area.
- Circle the safest place to wait out a storm:

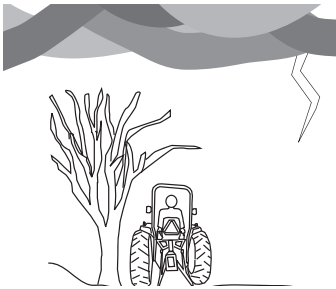

Under the nearest tree.

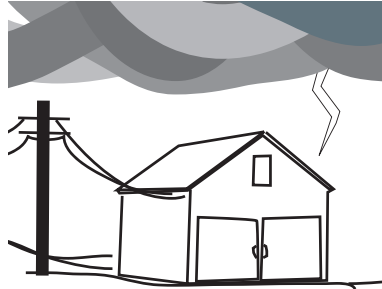

In the nearest shelter.

Conclusion

You can be killed or seriously injured if you are involved in a tractor accident. Almost all tractor accidents are preventable. By practicing safe work habits, you can prevent tragedy on the job. Take control of your own safety by following the practices outlined in this booklet. Use this information to keep your work experience safe.

Choose  safety

Quiz Yourself

Answers can be found on page 38.

Use the list of words to complete the following sentences.

slips and falls
drink
speed
right
extra riders
alcohol or drugs

- a. Never operate a tractor under the influence of _____.
- b. Never allow _____ on your tractor. One seat means one rider.
- c. Keep the tractor steps and operator's platform clean to prevent _____.
- d. Reduce _____ when turning, crossing slopes and on rough, slick, or muddy surfaces.
- e. When operating on a public roadway, always stay as far to the _____ as possible, making sure your attached implements are out of the way of other motorists.
- f. When working in hot or humid conditions, _____ plenty of water.

Quiz Yourself Solutions

Lesson 1, Page 7

1. What are the most commonly reported causes of serious injury and death from operating tractors? Circle the correct answer.
 - a. Tire blow outs, hydraulic fluid leaks, fire and lightning strikes
 - b. Rollovers, runovers, getting caught in moving parts and collisions**
 - c. Carbon monoxide poisoning, heat stroke, burns and being run over
2. Match the safety image with its meaning.

a. Watch out for rotating PTO shaft



b. Wear eye protection.



c. Don't get caught in moving parts.



Lesson 2, Page 11

1. Use the words to label the areas on the tractor that should be checked daily.

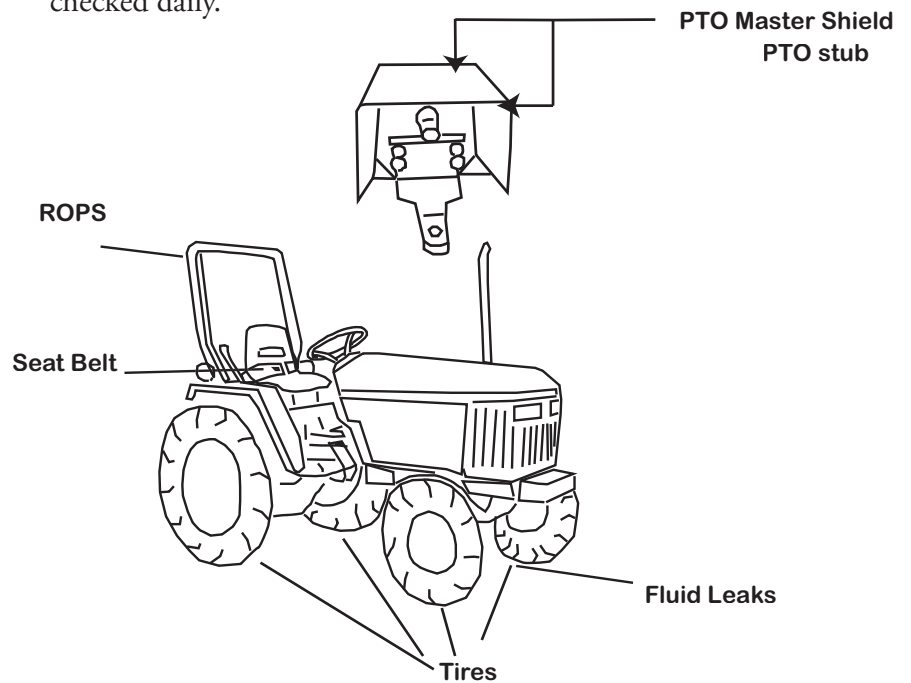

Lesson 2, continued

Use the list of words to fill in the blanks of the safe start up procedures.

facing
operator's seat
seat belt

2. Climb the steps facing the tractor with both hands on the grab bars.

3. Never start a tractor from anywhere other than the operator's seat.

4. Adjust the seat so your hands and feet can reach all controls and the steering wheel with the seat belt fastened.

Lesson 3, Page 15

Circle the correct answer to complete the sentence.

1. The most common type of rollover accidents are _____.

- a. side rollovers.
- b. front rollovers.
- c. rear rollovers.

2. Keep the heavy end of the tractor facing _____ when you must operate on a slope.

- a. up the hill
- b. down the hill

3. When tractor speed increases, it is _____ likely to rollover.

- a. less
- b. more

4. Circle the correct way for a tractor to operate on a hill.

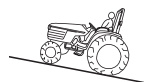
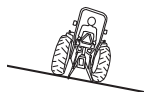
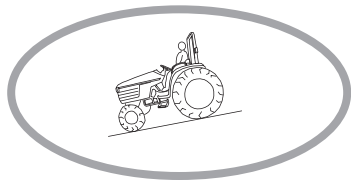

Lesson 4, Page 19

For each pair of drawings, circle the one that shows the operator using safe procedures.

1.

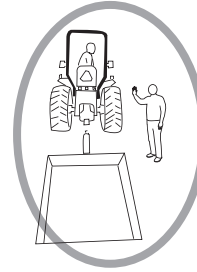

2.



3. Use words from the list to complete the sentences.

operator's seat

moving

branches

- a. Never attempt to mount a moving tractor.
- b. When driving, make sure you are clear of any low hanging branches, power lines or structures.
- c. Never start a tractor from anywhere but the operator's seat.

Lesson 5, Page 23

Use the list of words to fill in the blanks of the following sentences.

PTO system
toward
entanglements
hydraulic injection

1. Entanglements happen when you or a piece of your clothing becomes caught in moving equipment parts.
2. Crush points are formed when two objects are moving toward each other or when one object is moving toward a stationary object and the gap between them is getting smaller.
3. Keep all parts of the PTO System shielded and guarded.
4. Seek immediate medical attention if you suffer a hydraulic injection injury.
5. Draw a line from the word to the part it describes.
PTO master shield PTO integral shield

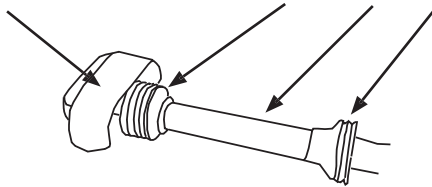

Lesson 6, Page 31

Use the list of words to complete the following sentences.

pulling
aware
laws
brake pedals
thunder

- a. Obey all traffic laws and signs when operating a tractor on a public roadway.
- b. Lock brake pedals together for road travel.
- c. Always be aware of what is going on around you when you are driving a tractor.
- d. Lock all towed equipment in the transport position before pulling it on the road.
- e. Seek shelter at the first sound of thunder, which means there could be lightning strikes in the area.

Lesson 6, Continued

f. Circle the safest place to wait out a storm:

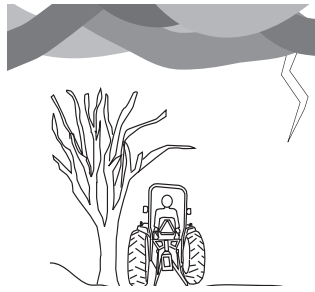

Under the nearest tree.



In the nearest shelter.

Conclusion, Page 33

Use the list of words to complete the following sentences.

slips and falls
drink
speed
right
extra riders
alcohol or drugs

b. Never operate a tractor under the influence of alcohol or drugs.

c. Never allow extra riders on your tractor. One seat means one rider.

d. Keep the tractor steps and operator's platform clean to prevent slips and falls.

e. Reduce speed when turning, crossing slopes and on rough, slick, or muddy surfaces.

f. When operating on a public roadway, always stay as far to the right as possible, making sure your attached implements are out of the way of other motorists.

g. When working in hot or humid conditions, drink plenty of water.

This page left blank intentionally for notes.

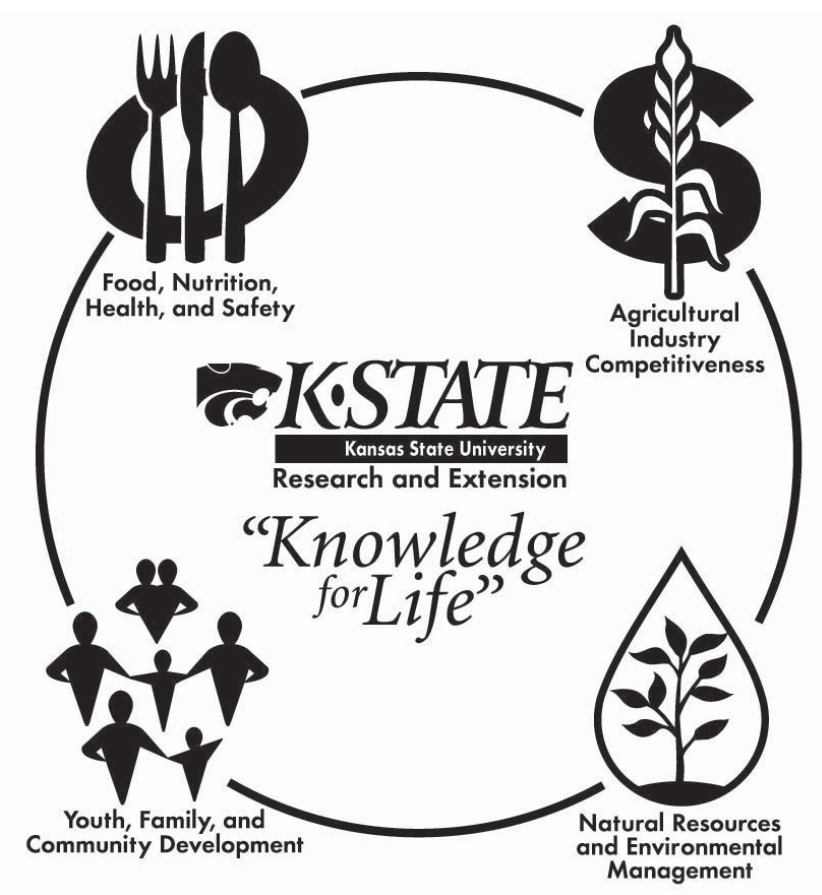

This publication is produced by K-State Research and Extension, Manhattan, Kansas, www.oznet.ksu.edu

Brand names appearing in this publication are for product identification purposes only. No endorsement is intended, nor is criticism implied of similar products not mentioned.

Kansas State University Agricultural Experiment Station and Cooperative Extension Service

MF 2708

April 2006

K-State Research and Extension is an equal opportunity provider and employer. Issued in furtherance of Cooperative Extension Work, Acts of May 8 and June 30, 1914, as amended. Kansas State University, County Extension Councils, Extension Districts, and United States Department of Agriculture Cooperating, Fred A. Cholick, Director.