



PRACTICAL SOLUTIONS FOR PESTICIDE SAFETY

Protecting Agricultural Pesticide Handlers



Disponible en Español

PRACTICAL SOLUTIONS FOR PESTICIDE SAFETY

Protecting Agricultural Pesticide Handlers

http://depts.washington.edu/pnash/practical_solutions

2012

Safety is the “work of changing minds. And it is not done overnight.”

~ Project participant

Editors: Kit Galvin, Jen Krenz, Pablo Palmández, Marcy Harrington

Layout & design: Stacey Holland



PACIFIC NORTHWEST AGRICULTURAL
SAFETY AND HEALTH CENTER

fishing · farming · forestry



SCHOOL OF PUBLIC HEALTH

UNIVERSITY of WASHINGTON

PACIFIC NORTHWEST AGRICULTURAL SAFETY AND HEALTH CENTER
University of Washington, Box 357234, Seattle, WA 98195-7234
pnash@uw.edu, (800) 330-0827, www.depts.washington.edu/pnash/

National Institute of Occupational Safety and Health Award #2 U50 OH07544



STATE OF WASHINGTON

DEPARTMENT OF AGRICULTURE

P.O. Box 42560 · Olympia, Washington 98504-2560 · (360) 902-1800

The Washington State Department of Agriculture (WSDA) was pleased to work with growers, managers, handlers, pesticide safety educators, pest control consultants and the University of Washington's Pacific Northwest Agricultural Safety and Health Center on this resource. We hope you find it helpful.

Washington is one of the most diverse agricultural states in the nation, featuring tree fruits, wine and table grapes, Christmas tree farms, nursery and greenhouses and many other farm products. The success of our vibrant \$40 billion industry depends on a well-trained workforce and the responsible use of agricultural chemicals. The entire community shares the responsibility for protecting our workers and our rural communities' health.

At WSDA, we take our role in ensuring the safe use of agricultural chemicals very seriously. In addition to regulating the registration, distribution and use of pesticides, our farmworker education programs are a critical piece of that work. We provide Worker Protection Standards and general pesticide safety classes, as well as more comprehensive training programs for pesticide handlers. Over 20,000 workers in Washington have benefitted from WSDA training programs, either by participating themselves or by learning from a graduate of one of our "train-the-trainer" seminars.

Agricultural workers need the right training and tools to work safely around pesticides and their residues and we want to be a resource for you.

Regards,

Dan Newhouse
Director

About this Guide

Practical Solutions for Pesticide Safety is a collection of solutions and ideas identified on farms and reviewed and developed in a partnership with farmers, educators, and researchers in Washington state.

We hope you try these solutions in your region and on your farm, and that these ideas inspire you to develop your own safety solutions. We would greatly appreciate hearing about any solutions you develop and your experience with this guide. Please call us (PNASH (800) 330-0827) or send an email (pnash@uw.edu).

Many of the solutions in this guide may be used or adapted for a variety of crop systems. Most solutions originate from farms that use airblast sprayers for applying agricultural chemicals to tree fruit, hops, and grapes. They were selected to be practical and to protect those most at risk – pesticide handlers and their families.

Read about why farmers came up with each idea and the science behind them. You will find pictures, illustrations, and instructions to assist you in making and adopting these solutions. We've also included tips and resources and additional information sources are listed in the back.

We wish to thank the many people that contributed to this guide. This is as much your guide as PNASH's. We appreciate your time, honest practical advice, and your commitment to a safe workplace and healthy community.

May this guide find you safe, happy, and prosperous!

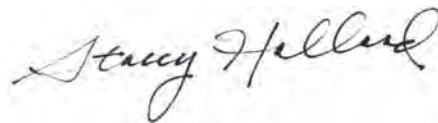
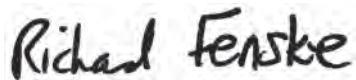

~ Project team at the
PACIFIC NORTHWEST AGRICULTURAL
SAFETY AND HEALTH (PNASH) CENTER

Guide FAQ

➔ What is a practical solution?

A practical solution is a work practice, tool, or facility that makes work easier for pesticide handlers; it is also a safety measure. The solutions in this guide were found or developed with the help of handlers, managers, and safety educators in Washington state. We identified these solutions as practical if they were

Useful

- Compatible with work activities
- Convenient for handlers and management
- Adaptable and affordable for other workplaces

Safe

- Helps to minimize pesticide exposure
- Does not create a new health or safety problem

➔ Who is this guide for?

Farm managers and pesticide safety educators, who can learn from each other's best practices and protect their employees and community.

➔ What about cost?

For each solution we give an indication of the cost using the symbols below. The range considers varying costs of materials and labor, and recognizes that farms may have these items on hand.

\$ - Low cost (\$0–\$100)

\$\$ - Moderate cost (\$100–\$500)

\$\$\$ - Larger cost/investment (more than \$500)

➔ How were the practical solutions found?

Practical solutions were identified in several different ways

- Interviews with experts in pesticide handling, farm management, and pesticide safety education
- Visits to farms and on-farm interviews with handlers and managers
- Recommendations from the Expert Working Group members and pesticide safety educators
- Reviews of pesticide safety measures developed and tested by other researchers and organizations

➔ How did the agricultural community participate?

Key to the project was an Expert Working Group that met to propose, discuss, and provide direction for the project. The group was a collaboration of industry experts – managers and handlers involved in the day-to-day work on the farm – and PNASH scientists. Along with the pesticide safety educators, advisors provided their expertise in and knowledge of orchard practices and production. Twenty-five farms and 95 handlers and managers participated in the farm visits and interviews and contributed many of the solutions in this guide. Nearly 1200 people participated in evaluating and selecting the solutions through **evaluation surveys, audience participation surveys at presentations, in-orchard tests, and the advisory committee for this document.** (Please see our *Acknowledgements* on page 45.)

➔ Where can I get more information on pesticide safety and related topics?

Specific resources are included in each section. A listing of additional information on pesticide and agricultural safety resources can be found on page 41.

Table of Contents

INTRODUCTORY LETTER	ii
ABOUT THIS GUIDE	iii
STOP	vii
PRACTICAL SOLUTIONS FOR PESTICIDE SAFETY	
Mixing & Loading	1
Metal Mixing Table	
Pesticide Trailer with Mixing Table	
Splash Shield	
Pre-marked Measuring Containers	
Nurse Tank	
Pesticide Application & Drift Reduction	9
Thermo-wind Meter	
Convex Side-view Mirror on Tractor	
Flagger on Public Roads	
Decontamination	15
Equipment Decontamination	
• Rinsate Containment System	
• Scrub Brush & Pressure Washer	
Personal Protective Equipment (PPE) Decontamination	
• Pre-washing PPE in Pairs	
• Portable Sink	
• Sloping Cement Pad	
Personal Decontamination & Pesticide Handler Facilities	
• Locker System	
Emergency & Sanitation Facilities	23
Emergency Decontamination & Field Sanitation Stations	
• Stationary Stations with Water Lines	
• Portable Stations with a Water Tank	
Ammunition Box to Store Emergency Eyewash	
Emergency PPE & Supplies in Resealable Bag	
Pesticide Storage Facilities	29
Minimizing Pesticides in Chemical Storage	
Spill Containment Trays & Tubs	
Reducing Family Exposure	33
Dedicated Vehicle for Handlers	
Vacuum Station for Vehicles	
Boot Bin	
Work Coveralls	
REDUCING EXPOSURES TO PESTICIDES	39
ADDITIONAL INFORMATION	41
National Regulations & Resources	
Washington State Regulations & Resources	
Heat Related Illness Educational Materials	
General Educational Materials	
BIBLIOGRAPHY	43
ACKNOWLEDGEMENTS	45
FEEDBACK FORM – POSTAGE-PAID MAILER	



Using the guide

- ➔ **The foundation for safe pesticide use** is to select the right pest control product and use it according to the label directions
- ➔ **This guide** is designed to supplement required regulatory practices, **not** replace them
- ➔ **Your local enforcement agencies** are the place to go if you have regulatory questions about these solutions
- ➔ Not all solutions are for all people, so consult with your handlers about what will work for them and for your operation



Before using any pesticide

- ➔ **Be smart:** Remember the pesticide label is the law
- ➔ **Be informed:** Read the pesticide product label and the Material Safety Data Sheet (MSDS); know the federal, state, and local regulations for worker safety and environmental protection that apply to your region
- ➔ **Be prepared:** Purchase the right protective equipment, set up pesticide handling and decontamination facilities, and train pesticide handlers before the start of each spray season
- ➔ **Be clean:** Wear clean PPE

After using any pesticide

- ➔ **Decontaminate surfaces:** Decontaminate surfaces such as sprayers, tractors, mixing tables, and containers
- ➔ **Decontaminate PPE:** Decontaminate PPE at the end of each work shift
- ➔ **Practice personal hygiene:** Wash hands to minimize contaminating other body parts or surfaces and shower daily

The US Environmental Protection Agency's (EPA) Worker Protection Standard (WPS) covers the requirements for worker safety for agricultural use of pesticides.

Some states have additional regulations: For information on local regulations contact the appropriate state regulatory agency and see *Additional Information* on page 41.

Mixing & Loading

Mixing and loading involves handling the pesticide concentrate. A recent study showed that on average, handlers who mixed and loaded pesticides had higher levels of pesticide exposure than those who did not (PNASH, Keifer 2011).

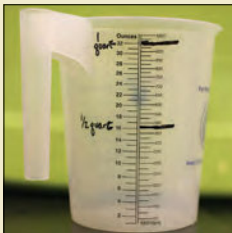
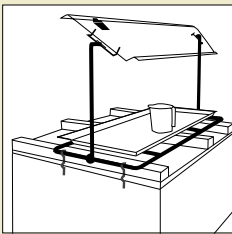
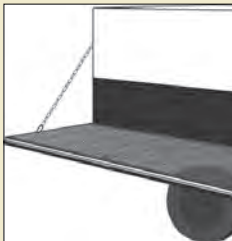

Metal Mixing Table 3

Pesticide Trailer with Mixing Table 4

Splash Shield 5

Pre-marked Measuring Containers 6

Nurse Tank 7

Mixing & Loading



- Place station in area with good drainage and away from wells and sinkholes
- Keep pesticides locked up when not in use, including at remote mixing and loading stations
- Mix pesticides on a surface that does not absorb pesticides, like metal
- If using apple bins, label "For Pesticides Only"
- Train handlers on proper lifting techniques
- Keep a spill response kit on hand to cleanup spills
- Make sure the water is turned off when pouring pesticides into tank



Spill Response Plans and Kits

- ◆ **Pesticide Spills – Prevention and Cleanup.** Pesticide Environmental Stewardship
<http://www.pesticidestewardship.org/spill/Pages/default.aspx>

Lifting Guidelines

- ◆ **Lessons for Lifting and Moving Materials.** WA L&I
<http://www.lni.wa.gov/IPUB/417-129-000.pdf>
- ◆ **Quick Tips for Lifting.** WA L&I
<http://www.lni.wa.gov/IPUB/417-055-909.pdf> (in English and Spanish)
- ◆ **Ergonomic Guidelines for Manual Material Handling.** NIOSH
<http://www.cdc.gov/niosh/docs/2007-131/pdfs/2007-131.pdf>



SOLUTION: Metal Mixing Table

This table is constructed out of metal with an expanded metal top and cannot absorb pesticides like wooden apple bins or tables. Handlers find it easier to use because it is taller and they don't need to bend over when measuring.



Alert! Install a spill containment tray under the table top to catch possible spills so concentrated pesticides do not soak into the ground. Slope the tray toward a drainage plug.

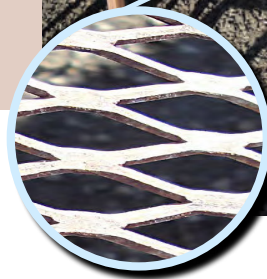

Idea **A farm manager built this mixing table ...** ... because he wanted a sturdy table that weathered well and did not absorb pesticides. He was also concerned that when his handlers used apple bins, they needed to bend over to look closely at marks on the measuring cups, resulting in an increased chance of face splashes and back strain.



"I like this table also for its height... It can prevent back injuries during pesticide handling."

~ Mr. Escareño

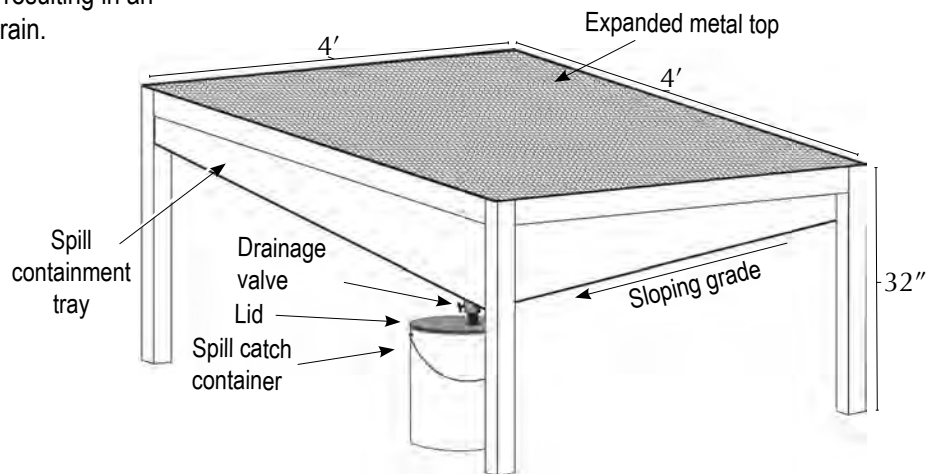

Evaluation Finding
 Nearly 75% of 199 handlers and managers surveyed said they would use the table if it were available and thought it would make handling easier.
 PNAH, Kenz 2010



Tip → Open the containment tray valve when not using the table, so that rainwater can drain

- Setup & Use**
- ⇒ Design dimensions for handler comfort while measuring. Paint with rust-resistant paint
 - ⇒ Size to ensure vehicles and machinery can go around tables and enter the next row
 - ⇒ Dispose of spilled material in containment tray according to your farm spill response plan

SOLUTION: Pesticide Trailer with Mixing Table

This pesticide trailer has the portable mixing table attached. The table is about waist-high.

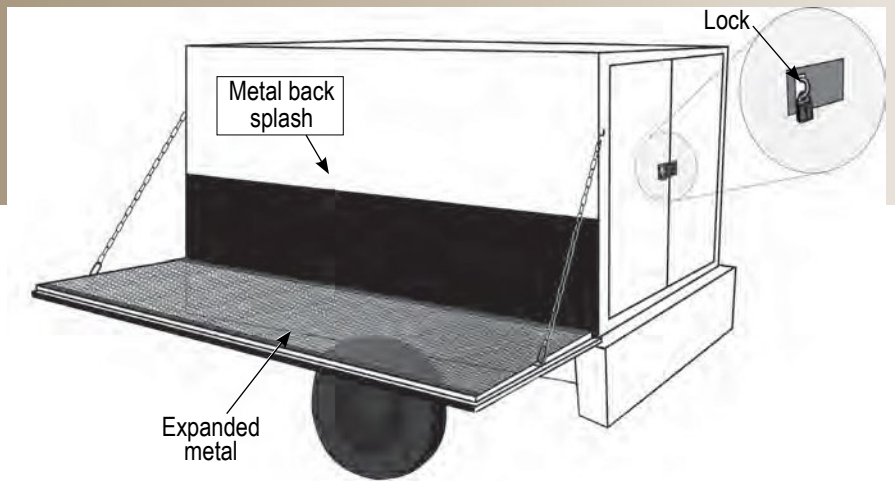

Secure pesticide containers before moving the trailer to prevent breaks and spills.

This design was recommended by a pesticide safety educator ...



... because fewer mixing tables are needed, it is easy to transport, and it can be stored out of the weather in the off-season. The drop-down table on the side can be at a comfortable height for mixers and not interfere with unloading pesticides.



"I like the fact that this trailer is of double purpose, for transportation and mixing.... I also like that in case of spills, the pesticide stays in the trailer and not in a vehicle."

~ Mr. Torres

Setup & Use

- ⇒ Design table height for handler comfort when measuring
- ⇒ Attach table to the side of the pesticide trailer with hinges and chains
- ⇒ Add secure hooks to keep the table folded up when moving trailer
- ⇒ Level the table before using



- ➔ Use a metal tray with a rim on top of the table to catch spills, especially if the table is wood
- ➔ Design trailer to minimize back strain when lifting and moving pesticide containers
- ➔ Include locking storage for the pesticides

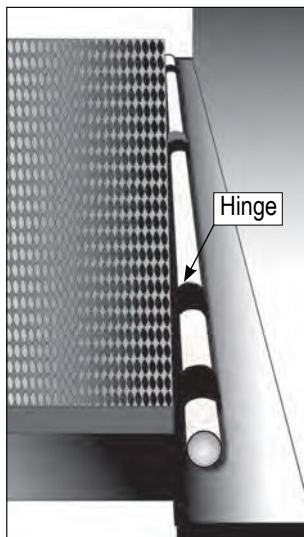
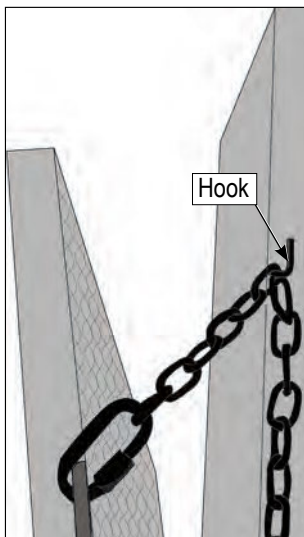

Hinges, hooks, and chains for attaching table to trailer



Metal tray with rim

SOLUTION: Splash Shield

This clear rigid sheet of Plexiglas® attaches to the mixing surface and provides an additional barrier from pesticide splashes. The mixer looks through the shield while measuring pesticides underneath. The shield height is adjustable. A tray placed on the mixing surface contains spills. The splash shield can be attached to the mixing surface for the entire season, adding extra protection.



The mixer must continue to wear eye protection and PPE as required by the label.

The Expert Working Group designed and tested the splash shield ...

Idea ... because splashes to the eye from mixing and loading are a common pesticide-related injury. They also wanted it to be easy to make with common materials and be easy to take apart for storage.

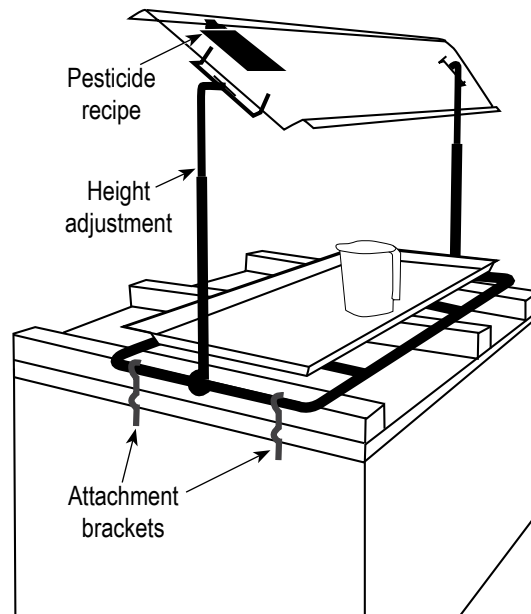

Tip

➔ Attach a clip to the shield so the mixing “recipe” can be placed in an easy-to-read location

“The tray contains pesticide spills... and allows me to collect the spilled pesticide and reuse it.”
~ Mr. Castro

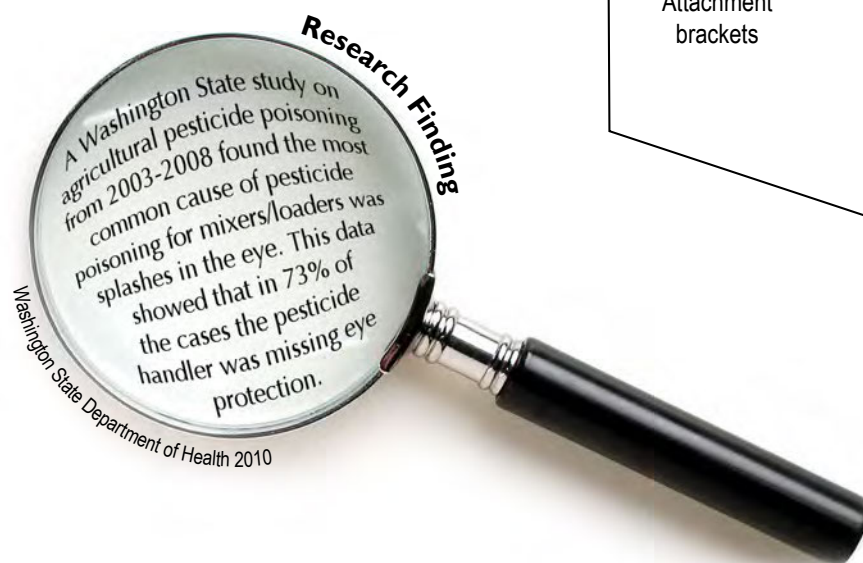

Setup & Use

- ⇒ Design splash shield to fit and attach to the mixing table
- ⇒ Construct the splash shield so it is easy to adjust the height and take apart for storage
- ⇒ Clamp the shield on the mixing surface and place the tray underneath
- ⇒ Decontaminate the shield and tray after each use

SOLUTION: Pre-marked Measuring Containers

Measuring containers for pesticides and other agricultural chemicals are marked to help handlers accurately measure liquid pesticide products. Food safety regulations may require the use of liquid measuring containers that are calibrated and marked by the manufacturer. Pre-marking is a visual and educational aid to use in addition to the manufacturer's marks.

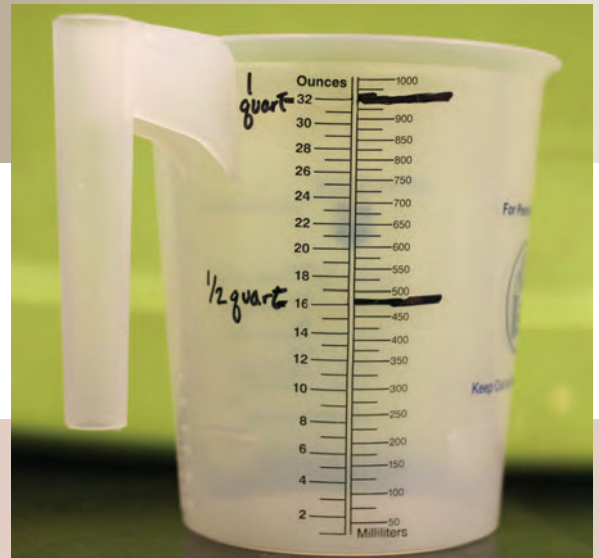

For accurate measure of dry products, weigh each batch separately, and do not measure additional batches by marking the containers. The size of the particles can change and the same volume may have different weights.

A farm manager thought of this idea ...

Idea ... when he had difficulty explaining gallon measurements to a handler used to the metric system. Instructing the handler to fill to a specific mark improved communications and reduced measurement error.



(Left) liter, (right) gallon



"It is easier to communicate with the pesticide handlers about the volumes and amounts of pesticides to be measured when spraying."

~ Mr. Escareño



- ➔ Use a 2 gallon measuring container for oils to minimize spills and lifting weight
- ➔ Provide education and training for handlers on the United States Standard Units for liquids and weights
- ➔ Pre-mark to make it easier to see when wearing eye protection or full-face respirator or if you wear glasses for reading
- ➔ Use different measuring cups for each product

Setup & Use

- ⇒ Use clear plastic measuring pitchers
- ⇒ Mark desired volume using permanent marking pens
- ⇒ Use black pens as some pesticide handlers may be color blind
- ⇒ Label each container "for pesticides only"
- ⇒ Check and replace markings before they wear off
- ⇒ Decontaminate measuring containers after each use



SOLUTION: Nurse Tank

Pesticides are mixed and loaded into a large tank. Nurse tanks are towed by tractors or are mounted on flatbed trucks. The pre-mixed pesticides are delivered to individual sprayers in the orchard. Only one mixer/loader and one mixing/loading station are needed, increasing efficiency and decreasing error. This solution is more cost-effective for large operations.

\$\$\$



Alert!

There is an increased risk of a large chemical spill if there is a vehicle accident. Avoid busy public roads.



Idea A farm manager chose this solution ...

... because he determined that using the nurse tank increased application efficiency per hour by 20%.

"Previously, we had a mixing station for each 50 acres of orchard and now one mixing station services about 335 acres. Applicators do not need to stop to mix and load new batches; they are topped off by the nurse tank and continue spraying. It is easier to monitor the pesticide inventory and only one employee is mixing and loading pesticides at a centralized location."

~ Mr. Milne

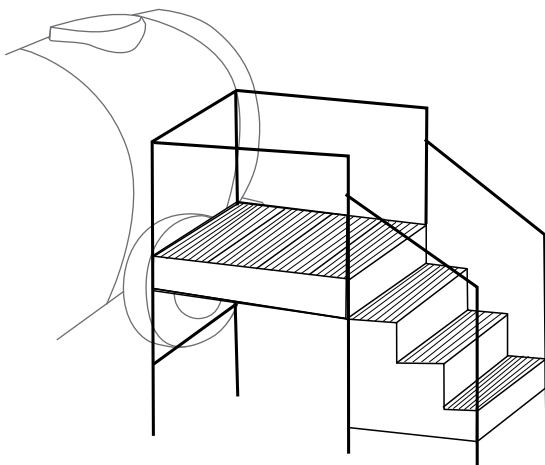

Stairs with railing for loading tank

Setup & Use

- ⇒ Determine the appropriate size for the nurse tank based on the acreage and the number of sprayers
- ⇒ Plan an efficient method to deliver pesticides to spray tanks in advance
- ⇒ Train more than one handler on how to operate the mixing and loading system for the nurse tank in case you need a backup
- ⇒ Install expanded metal stairs with railing for safer, easier loading
- ⇒ Develop and train employees on an emergency spill response plan for the nurse tank
- ⇒ Follow federal, state, and local regulations for the transport of pesticides
- ⇒ For nurse tanks mounted on flatbed trucks:
 - Use a tailgate lift or forklift to bring chemicals to the truck bed not be
 - Install fall-protection railing around mixing area on the flat bed

Pesticide Application & Drift Reduction

Pesticide drift is the leading cause of overexposure for bystanders and agriculture workers in Washington state (Washington State Department of Health 2010).



Thermo-wind Meter 11



Convex Side-view Mirror on Tractor 12



Flagger on Public Roads 13

Pesticide Application & Drift Reduction



- Use a tractor with a cab if possible to protect the applicator. Ensure the handler wears required PPE and the ventilation system is working properly
- Calibrate for “every drop to the crop”
- Notify your neighbors and all employees in the area before you spray
- “Don’t spray if the pesticide might stray!” Be aware of wind speed and direction, temperature, and inversions
- Stay aware of other workers, vehicles, and bystanders



- ◆ **Orchard Spraying.** Cornell University
<http://web.entomology.cornell.edu/landers/pestapp/apple.htm>
- ◆ **Air-blast Sprayer Calibration.** WSU
http://county.wsu.edu/chelan-douglas/agriculture/treefruit/Pages/Air-Blast_Sprayer.aspx
- ◆ **Drift Reduction and Nozzle Selection (Presentation).** Pesticide Environmental Stewardship
<http://www.pesticidestewardship.org/drift/Documents/Drift%20PES.pps>
- ◆ **Pesticide Drift Management.** Oregon State University
http://www.ipmnet.org/Pesticide_Drift_Artwork/Spray%20Drift%20lo%20res%20print.pdf
- ◆ **Optimize Ground Speed with Online Tool.** Washington State University
<http://pmp.wsu.edu/SprayTech.php>
- ◆ **Make your own Patternator to Check Spray Deposition.** Cornell University
<http://web.entomology.cornell.edu/landers/pestapp/PATTERNATOR.htm>



Tractor with cab



Basic wind meter (no batteries)

SOLUTION: Thermo-wind Meter

Check orchard temperatures and wind speed with this hand-held battery-powered meter to find out if weather conditions are correct for spraying on the farm.



Alert! Turn off tractor and sprayer when reading wind speeds as the air movement from the spray equipment will cause inaccurate readings.



A handler uses this solution ...
... because he found weather conditions varied between close-by locations and throughout the day.



"I use it every day when spraying.... Weather factors can change anytime when spraying in the orchard."

~ Mr. Carbajal

Setup & Use

- ⇒ Wear clean gloves when holding the meter in the field to avoid contamination
- ⇒ Check the accuracy of temperature and wind-speed readings before each spray session by comparing meter readings to a standard, for example a stationary mercury thermometer or mechanical wind gauge
- ⇒ Check wind speed in an open area to get an accurate reading. Trees or buildings will affect readings
- ⇒ Decontaminate meter after each use by following the manufacturer's cleaning instructions, and do not put meter in water
- ⇒ Store in a clean, dry place

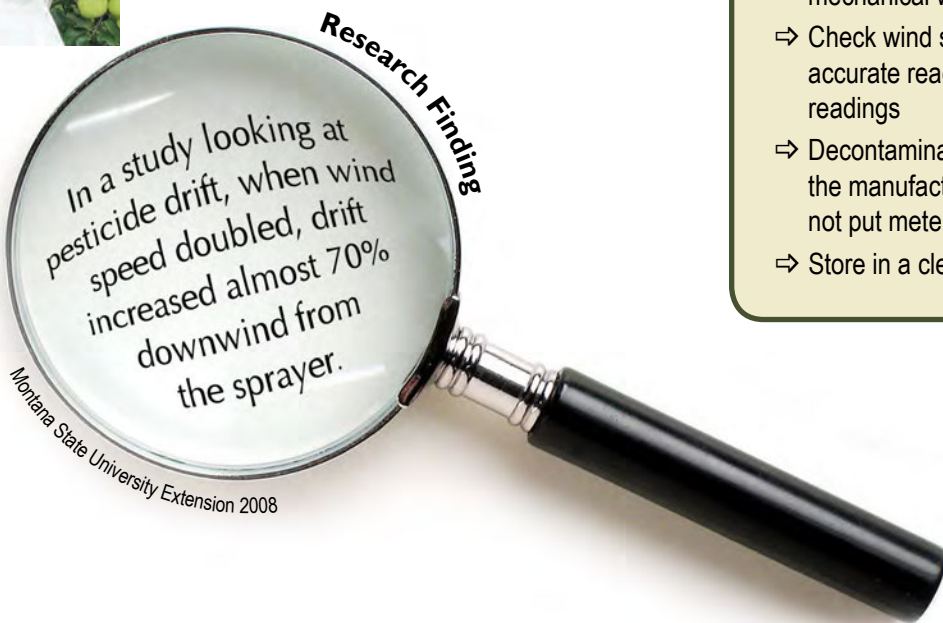

Wind speed and temperature display



➔ Water-resistant meters are available at agricultural supply stores and online

SOLUTION: Convex Side-view Mirror on Tractor

Convex side-view mirrors are mounted on either or both sides of the tractor to help applicators view the spray pattern and nozzle function.



Instruct applicators that the mirrors are only an aid and many operations will still require them to turn their heads to look to the side and behind them.

A handler started using a side view mirror ...



... because his neck and back were strained from frequently turning to check for drift and clogged nozzles. His PPE hood also blocked his vision when he turned his head. He has successfully used this solution for more than 18 years.



"It reduces the chemical exposure to the face and neck, and also reduces neck muscle strain."

~ Mr. McAllister

Setup & Use

- ⇒ Select mirror locations that optimize viewing the sprayer
- ⇒ Bend brackets to fit existing bolt holes in tractor hood
- ⇒ Confirm mirror location before completing installation
- ⇒ Remove pesticide residue on mirrors using single-use towels and dispose of them as hazardous waste
- ⇒ Be aware of tree branches that may break mirrors

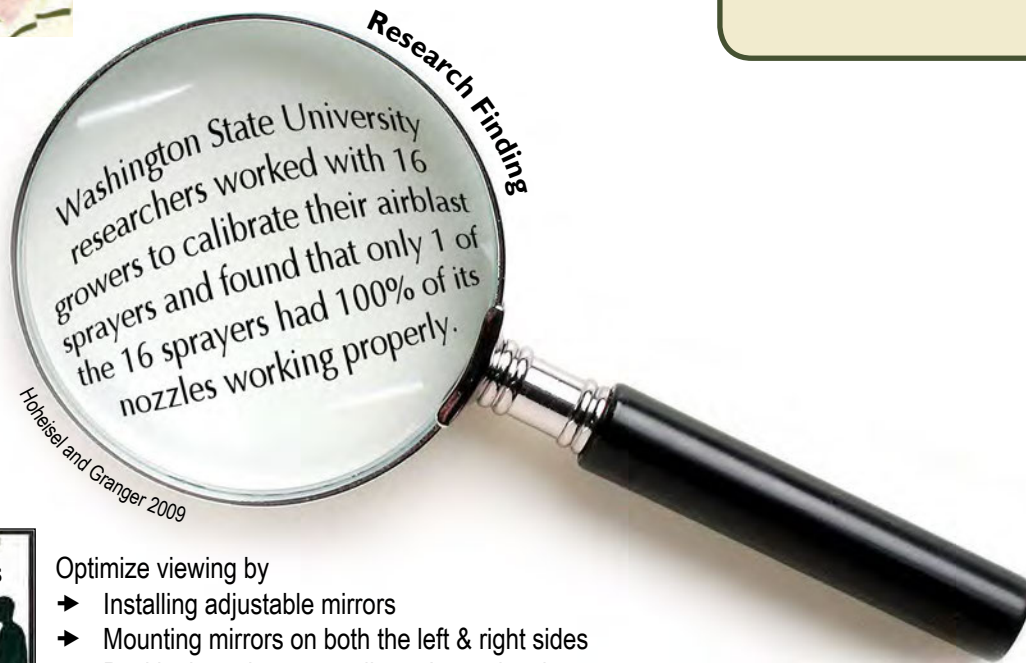

Applicator viewing spray pattern in the mirror



- Optimize viewing by
- ➔ Installing adjustable mirrors
 - ➔ Mounting mirrors on both the left & right sides
 - ➔ Positioning mirror at applicator's eye level

SOLUTION: Flagger on Public Roads

The flagger stands off to the side of the road and uses a flag to alert the applicator when a vehicle is approaching and when it has passed. The flagger and applicator are trained to use specific flag signals. The flagger is a pesticide handler, wearing the same PPE and having the same training as the applicator.



Check each label as some prohibit flaggers.



Before this orchard began using flaggers, the applicators would try to watch for traffic, but it was difficult for them to see approaching traffic from inside the rows.

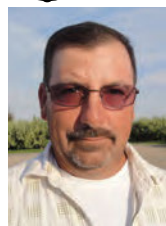

"The use of a flagger by public roads is for the safety of the workers and the public because the wind can change any hour or minute."

~ Mr. Madrigal

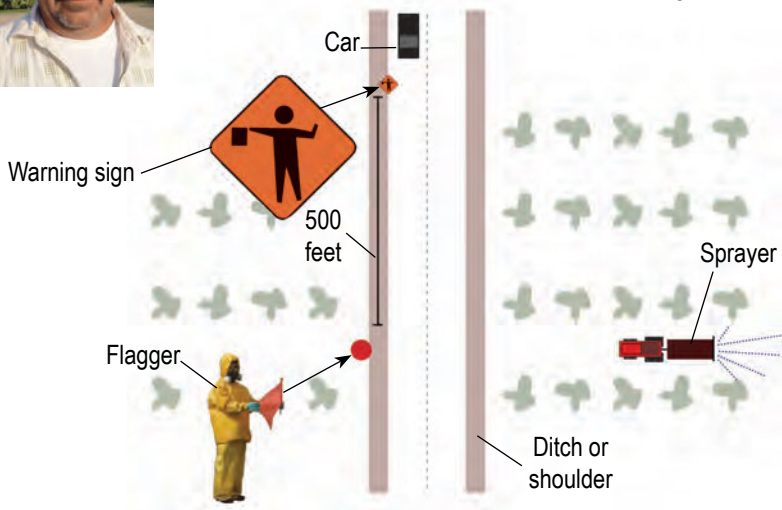

Setup & Use

- ⇒ Follow guidelines for mobile flagging operations in the Manual on Uniform Traffic Control Devices. Part 6 has information on flag dimensions and signaling motions
- ⇒ Place signs on side of road to notify approaching traffic that a flagger is working near the roadway
- ⇒ Train the flaggers and applicators how to use the needed signals ("Stop" & "Go")
- ⇒ Make sure flagger is located off the roadway and where he can be seen by the applicator
- ⇒ Train the applicator to turn his head to check for a "Stop" signal after first entering a row driving away from the flagger



- Provide pesticide training for flaggers. They are considered handlers
- Train the flagger to stand off the road and out of the way of passing vehicles to prevent being hit by a car

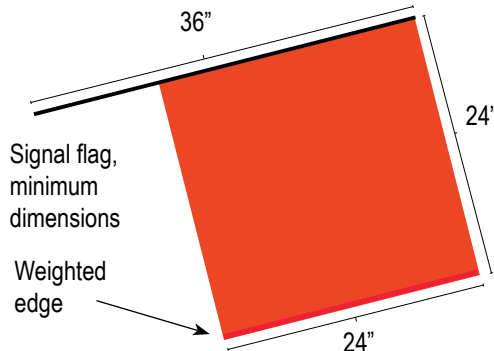
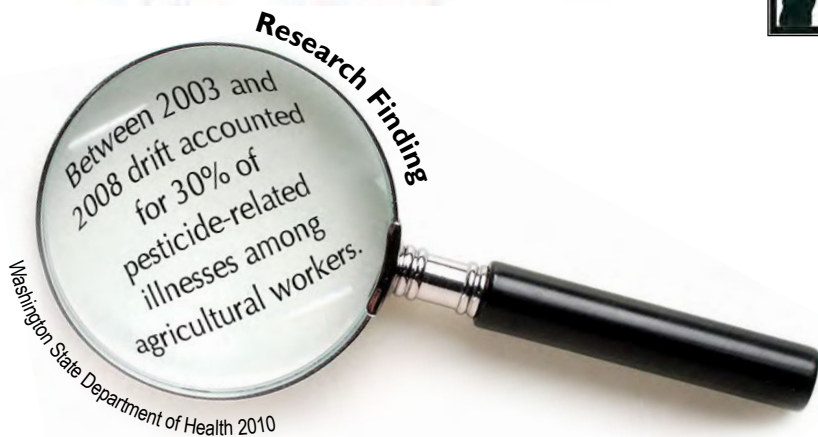

Decontamination

Decontamination is necessary to prevent pesticide handlers, other agricultural employees, and families from being exposed. Pesticide residues are easily transferred and distributed.

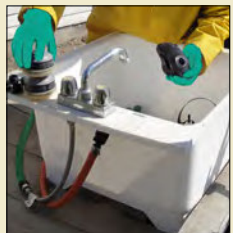
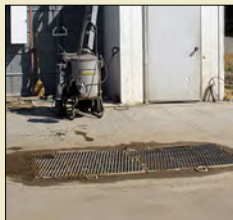

Equipment Decontamination

Rinsate Containment System 17

Scrub Brush & Pressure Washer 18

PPE Decontamination

Pre-washing PPE in Pairs 19

Portable Sink 20

Sloping Cement Pad 20

Personal Decontamination & Worker Facilities

Locker System 21

Decontamination



General

- Provide employees work time to properly decontaminate PPE and application equipment
- Dedicate separate staff for decontaminating PPE and equipment after applications so that cleaning is consistent and supervision is simplified
- Use brushes with plastic handles and bristles. Wooden handles and natural bristles can absorb pesticides

Equipment Decontamination

- Decontaminate within the application site as defined by the label so rinsate does not have to be transported or contained
- Decontaminate at different locations within the application area as defined by the label to prevent chemical build-up at a single location

PPE Decontamination

Remember

- “Clean to clean and dirty to dirty” when removing PPE so that clean PPE only touches clean PPE and dirty PPE only touches dirty PPE
- Wash the inside and outside of all PPE with detergent and water
- Rinse well and dry PPE before putting away

Personal Decontamination and Worker Facilities

- Implement a laundry service at your workplace for coveralls and other work clothes
- Install private showers for handlers in the changing room. Handlers are more likely to shower at work if they have privacy
- Instruct employees to wash before and after using the bathroom and before eating, drinking, or smoking



General

- ◆ **Your Decontamination Station (DVD).** Pesticide Broadcasting Network
<http://www.pubs.wsu.edu/ItemDetail.aspx?ReturnTo=0&ProductID=15349>

Equipment Decontamination

- ◆ **Reducing and Managing Wastes from Pesticide Containment Areas.** Department of Ecology
<http://www.ecy.wa.gov/pubs/94186.pdf>

PPE Decontamination

- ◆ **12-step Personal Protective Equipment Removal and Decontamination Process.**
Washington State Department of Agriculture
<http://www.agr.wa.gov/PestFert/Pesticides/WorkerProtection.aspx#Resources> (English and Spanish)

Personal Decontamination and Worker Facilities

Laundering Instructions

- ◆ **Dirty Work Clothes: How Should I Wash Out Pesticide?** National Pesticide Information Center
<http://www.npic.orst.edu/capro/DirtyClothes.pdf>
- ◆ **What to do When Clothes are Soiled with Pesticide.** Iowa State University
<http://www.extension.iastate.edu/publications/pm1663b.pdf>

Equipment Decontamination

SOLUTION: Rinsate Containment System

This system captures rinsate from application equipment decontamination. Decontamination takes place over a cement pad that drains into a shallow, steel grate-covered cement reservoir. Rinsate is transferred to a labeled application site.



Alert! Do not mix rinsates from different applications, because they may not be allowed on the same labeled application site. Also, chemicals in different rinsates may not be compatible, and if mixed would be hazardous waste and expensive to dispose.



A manager installed a similar system because water from equipment decontamination made the shop yard muddy and the orchard management wanted to remove pesticide residues and dispose of the rinsate according to the label.

"This is the best way to safely dispose of rinsate from cleaning up tractors and sprayers."

~ Mr. Oliver



- ➔ Use chemical resistant concrete as some pesticides could corrode the concrete
- ➔ Capture debris with a mesh screen over the grate
- ➔ Construct a berm around tanks or other contaminant to capture leaks
- ➔ Provide a roof over the pad to keep out rain water

Setup

- ⇒ Design pad large enough to hold the vehicle and to catch overspray from pressure washer
- ⇒ Make the reservoir large enough to hold the rinsate volume or use a small holding tank
- ⇒ Design a low spot in the reservoir for complete pump-out
- ⇒ Install easy access for removing solids/sludge from the reservoir or tank
- ⇒ Cover reservoir with a metal grate
- ⇒ Lay gravel at the entrance to prevent tracking dirt on the pad
- ⇒ Ensure system does not have trip hazards

Use

- ⇒ Rinse pad with clean water after decontaminating vehicles
- ⇒ Pump rinsate into a tank
- ⇒ Dispose of rinsate and solids/sludge on a labeled application site after each use

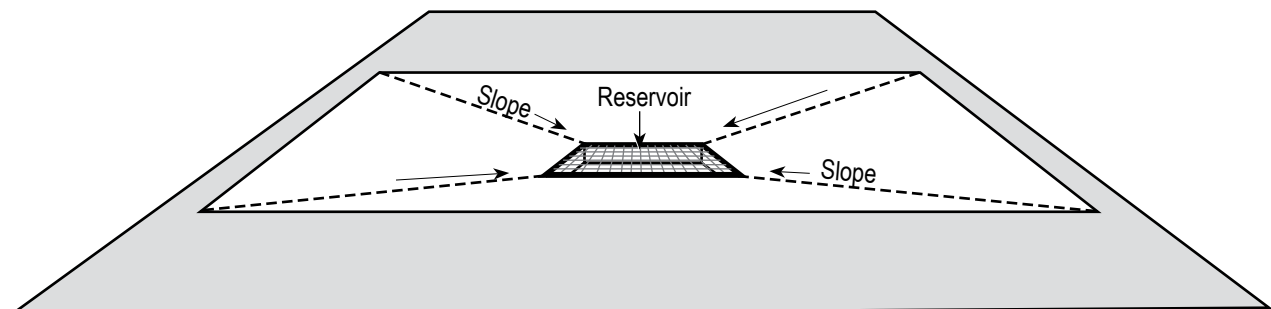

Side view of Rinsate Containment System

SOLUTION: Scrub Brush & Pressure Washer

Use both a scrub brush and pressure washer for cleaning sprayers and tractors. Pressure washers are especially good for removing dirt and debris from hard-to-reach places on the equipment. Thorough cleaning with scrub brushes provides better overall decontamination.

\$-\$\$\$



Alert!

Make sure that the pressure washer is grounded to prevent possible electrocution of the operator



The Expert Working Group wanted to know ...

... if scrubbing with soap and water or a pressure washers was more effective in cleaning application equipment. They had heard different opinions. The results (see below) show that soap and a scrub brush is more effective. Yet, pressure washing is good for hard-to-reach places.

"A mechanic in the orchard noticed that even after cleaning the sprayers with a brush, there was still residue in hard-to-reach spots.... The pressure washer turned out to be a successful idea."

~ Ms.Schott

Setup & Use

- ⇒ Determine pressure and temperature settings that will clean, but not damage, equipment
- ⇒ Use the proper eye protection for using a pressure washer and the PPE required by the pesticide label
- ⇒ Rinse equipment with the pressure washer to remove dirt and debris, especially in hard-to-reach places and mechanic access points, to reduce exposure to those repairing equipment later
- ⇒ Scrub equipment with brush, soap, and water
- ⇒ Rinse with hose or pressure washer

Research Finding
Only 10% of handlers were properly maintaining or washing spray equipment in a study of suspected pesticide-related illness cases in Washington state over 2003-2008.
Washington State Department of Health 2010



- Provide employee training on both proper scrubbing and pressure washer use
- Check oil and gas levels each time the pressure washer is used
- Drain residual water from the pressure washer before storing for the winter
- Install an overhead swinging arm to suspend the pressure washer hose to prevent it from dragging on the ground, creating a trip hazard and collecting pesticide residues

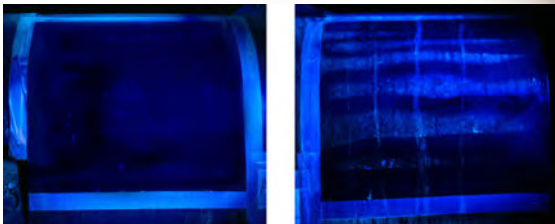
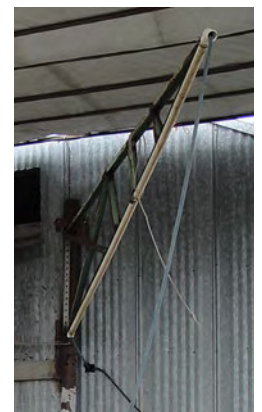

The scrub brush and soap cleans the spray tank thoroughly (left). The targeted pressure washer spray misses large areas of the spray tank (right).

"I like to clean with the swinging arm system. I can clean the equipment better, which also helps with greasing and repairing."

~ Mr.Torres

PPE Decontamination

SOLUTION: Pre-washing PPE in Pairs

Pesticide handlers take turns pre-washing each other's suits, boots, and gloves while they are still wearing all their PPE. They use soap, water, and a scrub brush. Afterward, each handler finishes decontaminating his own PPE.



This practice should be voluntary because some handlers will not be comfortable pre-washing in pairs.



A manager thought of the solution ...

...because he was concerned about pesticide residues on the PPE splashing on handlers' work clothes when they decontaminated their PPE. The handlers liked the idea and continue to use it.

"Our handlers like to do this practice and I like it too because pre-washing PPE reduces splashes.... Besides, it is easy to do."

~ Mr. Castro

Setup & Use

- ⇒ Instruct pesticide handlers on how to pre-wash PPE
- ⇒ Provide a cement pad or gravel for the pre-washing
- ⇒ Use dish detergent and a plastic hand-held scrub brush (with plastic bristles so it does not absorb pesticides)
- ⇒ Rinse with a hose or under an outside shower if available



- Train and remind handlers that they must thoroughly decontaminate their PPE after pre-washing

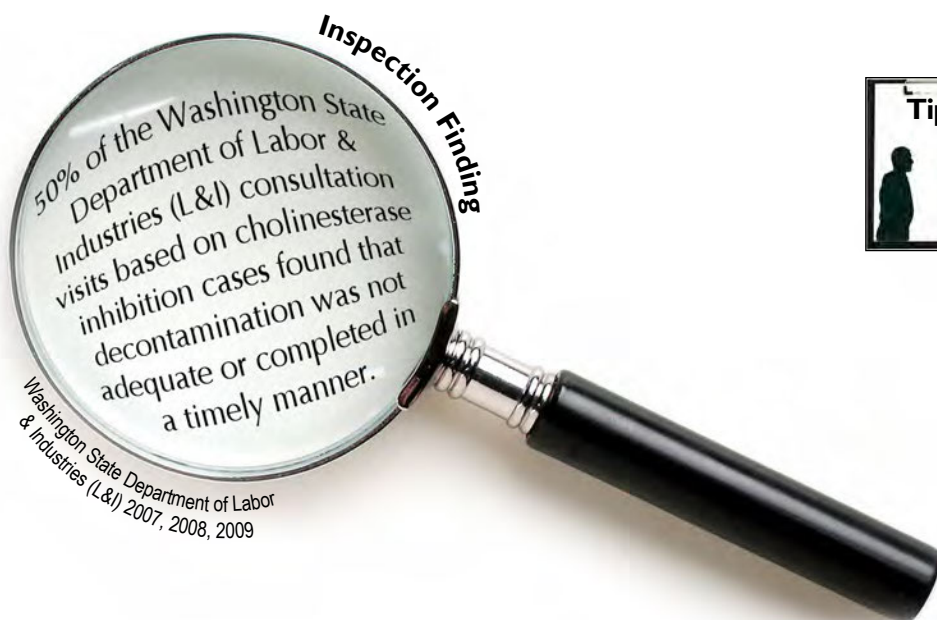

SOLUTION: Portable Sink

A sink is mounted on a table and connected to a hose. Smaller items can be washed in the sink. Larger items can be scrubbed on the table. The sink is light weight and can easily be moved to other locations or storage.



Alert!

Use a metal table if possible. Wooden tables and apple bins can absorb pesticides.



A manager set up this sink system ...

...because he found thorough cleaning of PPE is easier. The sink can be used for cleaning smaller items and soaking PPE. The raised sink also reduces back strain.

"It's easier, comfortable, and safer to wash the respirator and gloves in the portable sink than using a hose."

~ Mr. Castro

Setup & Use

- ⇒ Set up in an area with good drainage
- ⇒ Connect sink to water supply
- ⇒ Use a hose or other method for sink drainage
- ⇒ Provide detergent and plastic scrub brushes

SOLUTION: Sloping Cement Pad

This is a surface used for PPE decontamination. The cement pad is a hard, raised surface, so handlers don't need to bend over and the water can drain away from the handler.



Alert!

Install gravel around cement pad for drainage and to prevent water build up and a muddy work area.



A manager came up with this idea ...

... because he found thorough decontamination of PPE was difficult, especially when handlers had to bend over to scrub their PPE. The sloping cement pad provides a hard surface so the handler can scrub with pressure. The raised surface helps to prevent back strain.



"This 'lavadero' has been of great benefit.... A solid base is necessary to remove residues accumulated on the equipment. What is important is that the PPE is the cleanest possible before it is reused."

~ Mr. Garcia

Setup & Use

- ⇒ Include a drainage trough at the bottom
- ⇒ Select a location and use gravel for good drainage
- ⇒ Determine the best angle and height for decontaminating PPE
- ⇒ Make the pad large enough so two handlers can use it at the same time
- ⇒ Add a raised edge on the sides of the pad to minimize splash



➤ Install a box close by to store decontamination supplies such as soap and scrub brushes

Personal Decontamination & Worker Facilities

SOLUTION: Locker System

This system uses two lockers for each handler to prevent potential contamination of street clothes from PPE by storing decontaminated PPE and street clothes separately. Each type of locker is located in a separate room or area to prevent cross contamination. Separate storage of street clothes also helps to reduce unintentional exposure to family members from pesticide residues on street clothes.

\$\$



Alert!

Provide individual locks or controlled access to areas where street clothes and personal items are stored.



Idea

Double locker systems are used in many industries where workers are around hazardous chemicals to minimize worker exposure and unintentional work-to-home transfer of chemicals.

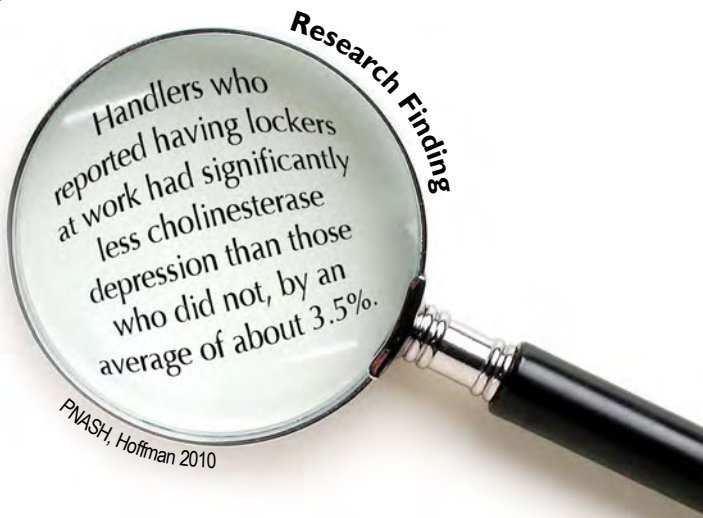

PNASH, Hoffman 2010

Setup & Use

- ⇒ Install lockers for PPE and street clothes storage in separate rooms if possible
- ⇒ Assign separate lockers for each handler
- ⇒ Provide space and seating for removing work boots and putting on street shoes
- ⇒ Provide training for handlers on the proper use of the lockers:
 - Importance of separate storage of street clothes and PPE
 - Decontamination of PPE before entering locker area
- ⇒ Keep the locker areas and the insides of the lockers clean through routine housekeeping
- ⇒ Clean using mops or damp cloths. Sweeping puts the dust in the air, increasing the possibility of exposure to pesticide residues

Double Locker System

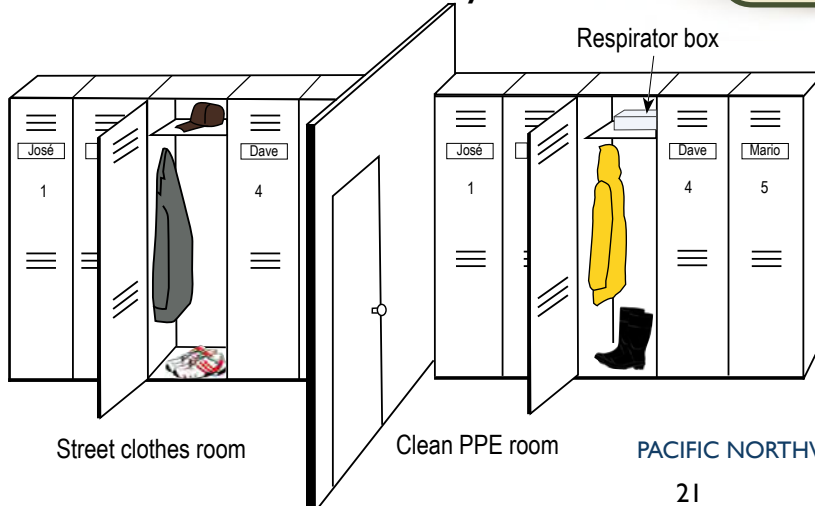

- Provide a plastic storage box for the clean respirator storage
- Provide showers for handlers to immediately remove pesticide residue on their skin and hair. This helps to minimize the work-to-home transfer of pesticide residues

Emergency & Sanitation Facilities

Workplace investigations show that an emergency eyewash is often missing (PNASH, Jansen 2010). Make sure there is an eyewash station in place and that each handler has immediate access to a personal emergency eyewash.

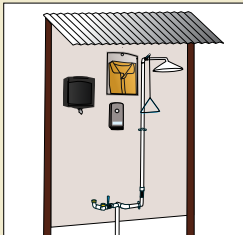

Emergency Decontamination & Field Sanitation Stations 25

Stationary Stations with Water Lines 26

Portable Stations with Water Tanks 26

Ammunition Box to Store Emergency Eyewash .. 27

Emergency PPE & Supplies in Resealable Bag 28

Emergency & Sanitation Facilities



- Develop an emergency response plan
- Train handlers on the emergency response plan and the use of emergency equipment
- Conduct mock emergency drills to practice and reinforce understanding of the procedures and equipment. In a real emergency, fast action is needed and there is not time to “read the manual”
- Maintain emergency and decontamination equipment according to the manufacturer’s instructions
- Test routinely to make sure equipment meets regulatory requirements



- ◆ **Safety Standards for Agriculture: Accident Prevention Program, First-aid Requirements.** WA L&I
<http://www.lni.wa.gov/wisha/rules/agriculture/HTML/part-b.htm>
- ◆ **Emergency Washing (Eyewash).** WA L&I
<http://www.lni.wa.gov/Safety/Topics/AtoZ/EmergencyWash/default.asp>
- ◆ **Safety Standards for Agriculture: Field Sanitation.** WA L&I
<http://www.lni.wa.gov/wisha/rules/agriculture/HTML/part-g.htm>

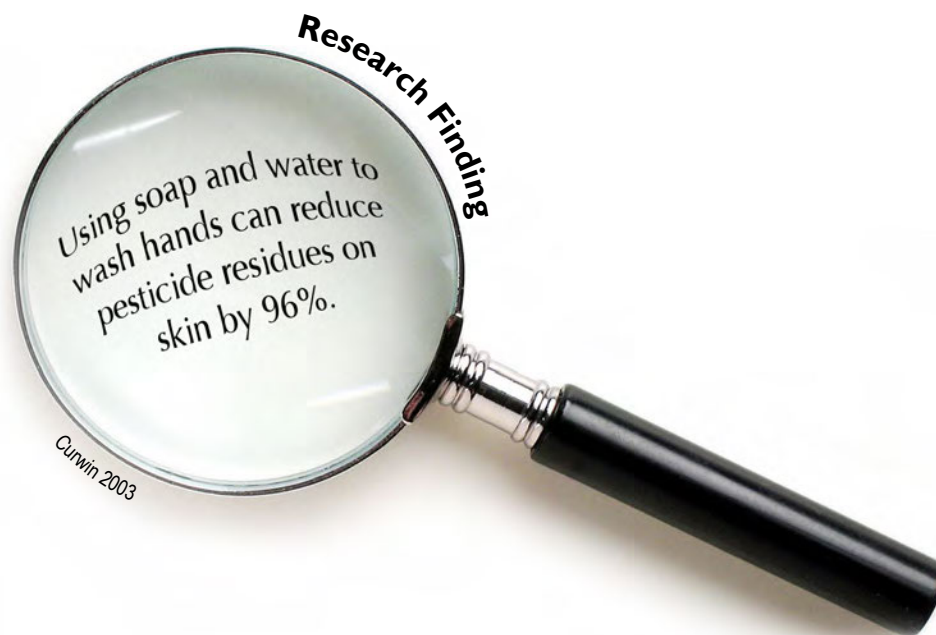

SOLUTION: Emergency Decontamination & Field Sanitation Stations

All-in-one stations have the equipment and supplies to provide first aid in case pesticide gets on the body, splashes in the eye, or soaks clothing. They provide soap, water, and towels for hand washing, emergency clothing, and spare PPE. They may be connected to a water line or be self-contained with a water supply tank. Stations may be mounted on a trailer so they can be easily moved to different locations.

\$\$-\$\$\$

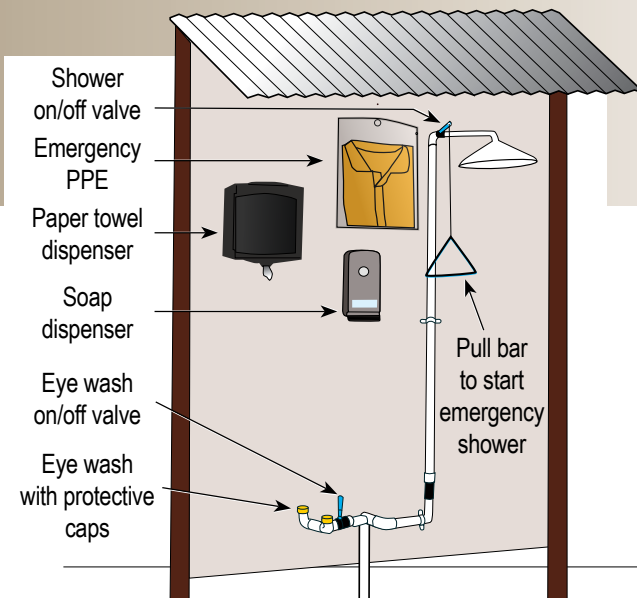

Alert!

Spray drift may contaminate the station. Protect soap, paper towels, and spare PPE by putting them in a box or cabinet.

Setup & Use

- ⇒ Locate stations within 50 feet of mixing and loading areas and one quarter mile of applicators
- ⇒ Stock stations with required equipment and supplies (see *Additional Information* on page 41)
- ⇒ Ensure water for the emergency eyewash and showers is potable (meets drinking water standards)
- ⇒ Activate stations that have waterlines weekly to flush lines and check that they work properly
- ⇒ Check water supply levels and test water quality of a self-contained system before each application day and as per regulations
- ⇒ Inspect the stations at the start of each season and on a routine basis to ensure the equipment is clean and operating properly, and all supplies are in place

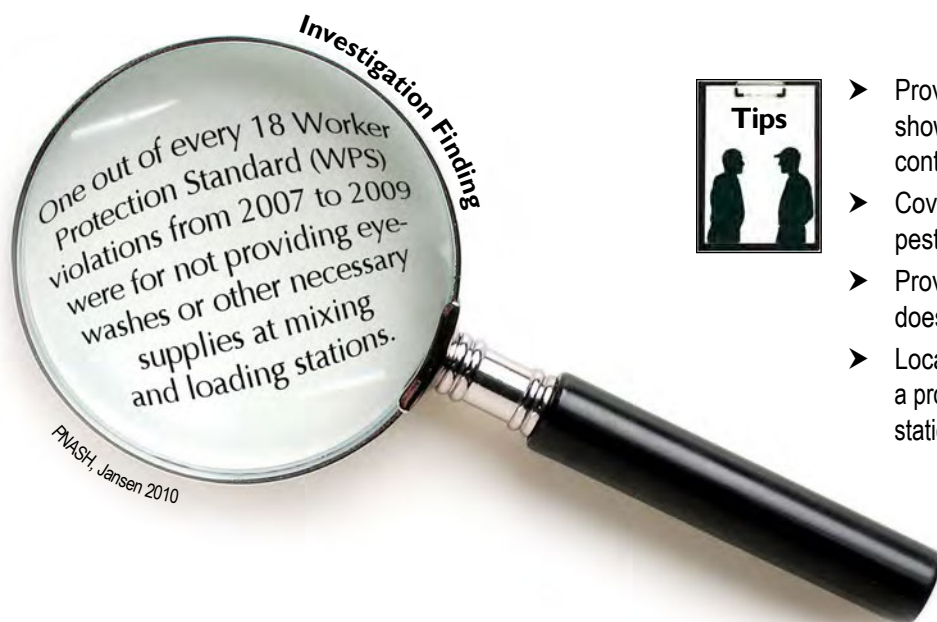

Tips

- Provide walls or curtains for the emergency shower. Handlers are more willing to remove contaminated clothing if it is private
- Cover eyewash nozzles to keep off dust and pesticide residues
- Provide shade for the emergency eyewash so it does not become too hot
- Locate potable drinking water and paper cups in a protected location separate from the emergency station

Stationary Stations with Water Lines

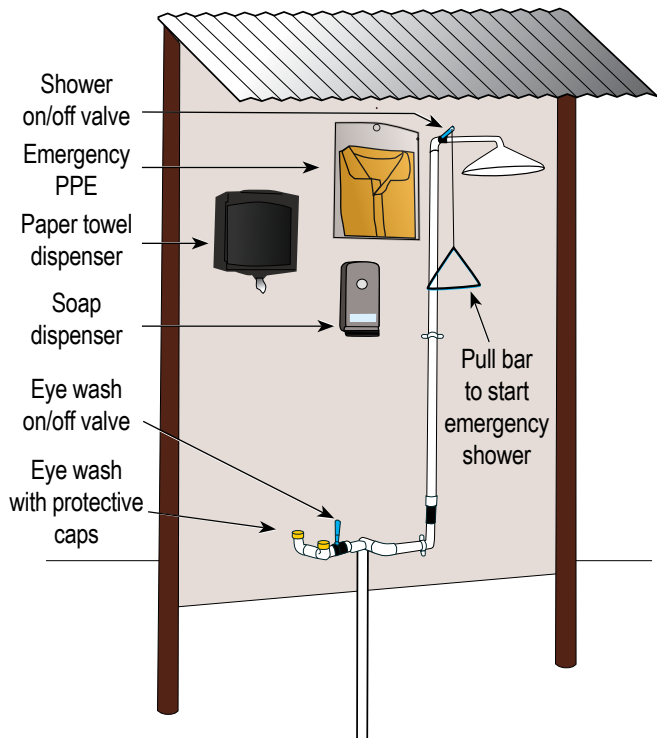

The awning protects the station from sun and rain. Place gravel around the station for good drainage.



The signs on the station make it easier to see the different facilities. The shower is enclosed to provide privacy. The “panic bar” makes door easy to push open in case of emergency.

Portable Stations with Water Tanks



Water is supplied to the sink and shower by a gravity fed system from a water tank located on top of the shower. The station provides privacy for employees.



Water pressure is provided by a 12-volt battery powered pump that is carried on board along with a water tank.

Phil Olsen

Check with local regulatory agency to ensure emergency and sanitation station meets requirements

SOLUTION: Ammunition Box to Store Emergency Eyewash

This box provides clean storage for the personal eyewash bottle. It is readily available and easy to open in an emergency.



The eyewash water could become too hot to use if the box is located near the motor or transmission or is exposed to the sun for long periods.

A manager thought of using an ammunition box ...



... when he saw the ammunition box on the tractor for storing tools. The PVC pipes he was using before had lids that would stick and be hard to remove in an emergency.

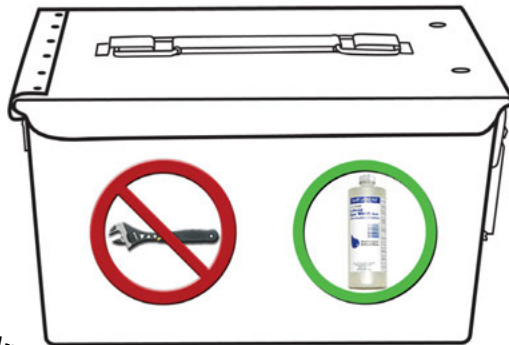

Setup & Use

- ⇒ Buy an ammunition box that is wide and shallow enough for handlers with large hands to reach inside
- ⇒ Attach the box on the tractor in a location that is easy for the applicator to reach within 10 seconds at all times
- ⇒ Make sure the box does not interfere with normal functions of the tractor or driver
- ⇒ Label the box with symbols for “Emergency Eyewash Only” and “No Tools”
- ⇒ Check the box to make sure lid is operating properly and emergency eyewash is full and sealed before each application
- ⇒ Use the entire bottle to rinse eyes. Complete the 15-minute minimum rinse at the eyewash station

- Replace eyewash before the expiration date on the bottle
- Keep the eyewash from getting too hot:
 - Consider a plastic ammo box
 - Paint the box white to reflect heat
 - Attach the ammo box to the tractor with a bracket to keep it separate from the hot tractor, especially the engine.
- Provide a “cradle” to keep the bottle from moving

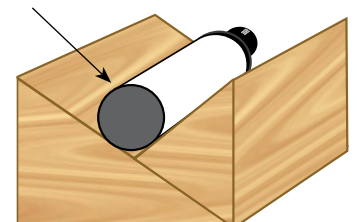

Investigation Finding

One out of every 20 WPS violations from 2007 to 2009 were for not providing a pint of emergency eyewash immediately available to the handler.

PNASH, Jansen 2010



SOLUTION: Emergency PPE & Supplies in Resealable Bag

Emergency supplies and PPE are stored in a resealable plastic bag inside a tractor cab. If the applicator exits the cab, an extra set of clean PPE is available to change into before re-entering the cab. The bag can also contain emergency supplies like spare respirator cartridges for the products being applied. A similar bag can be used to store spare PPE and overalls at an emergency decontamination station.



Alert! Take care to not contaminate the inside of the cab when changing into clean PPE.



A manager thought of using the plastic bag ...

... because he realized that the inside of the cabs could be contaminated after the handlers got back into the cabs. Handlers need to leave the cabs if nozzles get clogged or there are mechanical problems.



- Use a small plastic bucket or small container with a tight fitting lid as an alternative to a plastic bag
- Train handlers to put contaminated items in the garbage bag and not to mix contaminated and clean items in the same bag



Emergency supplies

Setup & Use

Stock the bag with needed items including:

- ⇒ Thin and thick nitrile gloves
- ⇒ Chemical-resistant boot covers to keep boots clean
- ⇒ Emergency eyewash (at least 1 pint)
- ⇒ Respirator cartridges required for the pesticide being applied
- ⇒ Extra nozzles to replace any that stop working
- ⇒ Earplugs
- ⇒ Chemical resistant goggles
- ⇒ Clean PPE suit
- ⇒ Plastic garbage bag for contaminated PPE

Train handlers to

- ⇒ Put on earplugs and chemical resistant boot covers, put eyewash in an easy-to-reach location, lay out clean gloves, and open garbage bag before they exit the cab
- ⇒ Remove boot covers and place clean boots in cab one at a time
- ⇒ Remove contaminated PPE and gloves before entering the cab
- ⇒ Put contaminated items in garbage bag and securely tie the bag
- ⇒ Put on clean PPE
- ⇒ Dispose of the garbage bag as hazardous waste

Pesticide Storage Facilities

Managing pesticide inventory is important in order to control costs and protect workers, the community, and families.

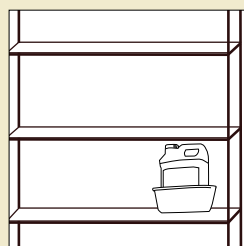

Minimizing Pesticides in Chemical Storage 31

Spill Containment Trays & Tubs 32

Pesticide Storage Facilities



- Add a containment system or berm to contain leaks and spills
- Lock pesticides in a legal storage area that meets regulations
- Keep chemicals cool in the summer and don't let them freeze in the winter
- Manage chemical inventory to minimize on-site storage
- Use up open product containers if possible
- Return unopened product containers to vendor at the end of the season
- Work with your crop protection consultant to help manage inventory



- ◆ **Pesticide Storage.** Washington State Department of Agriculture
<http://agr.wa.gov/PestFert/Pesticides/Storage.aspx>
- ◆ **Waste Product Disposal.** Washington State Department of Agriculture
<http://agr.wa.gov/PestFert/Pesticides/WastePesticide.aspx>
- ◆ **Pesticide Spills – Prevention and Cleanup.** Pesticide Environmental Stewardship
<http://pesticidestewardship.org/spill/Pages/default.aspx>

Pesticide Container Cleaning and Disposal

- ◆ **Pesticide Container Cleaning and Disposal.** WA Department of Ecology
<http://www.ecy.wa.gov/pubs/0104024.pdf>
- ◆ **Pesticide Container Cleaning and Recycling (DVD).** WA Department of Ecology
Hazardous Waste and Toxics Reduction Program (360) 407-6700
- ◆ **Northwest Ag Plastics and WAPCA Plastic Container Recycling.**
<http://www.nwagplastics.com>

Empty Pesticide Container Storage



Proper storage

Garnet Cooke, Oregon OSHA



Improper storage

Garnet Cooke, Oregon OSHA

SOLUTION: Minimizing Pesticides in Chemical Storage

This practice is to manage the inventory and purchase only the amount of pesticide needed for the season, return unopened containers to the supplier at the end of the season, and safely store partially used containers for the next season.

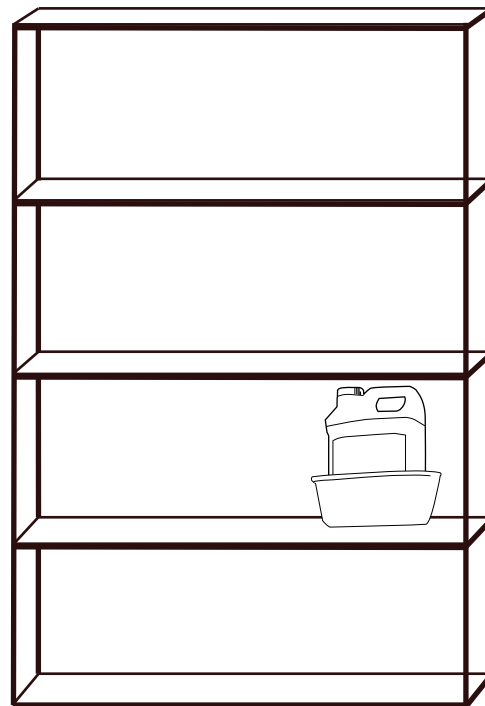

Many pesticides do not have expiration dates on the packaging. To help with tracking, write purchase dates on removable stickers and place on containers. If dates are written directly on the pesticide containers, the distributor will not accept them if you try to return them at the end of the season.

A manager thought of the solution



...when he started to more closely watch inventory and track the pesticides used. He saw money was being wasted on pesticides that were not used. Pesticides accumulated in the storage area and became old and less effective. When a pesticide label changes and a product is phased out, it is expensive to dispose of old pesticides as hazardous waste.



"I have been using this system for many years.... we know better what we have in storage, we don't keep in storage pesticides not to be used anymore, and costs decrease."

~ Mr. Castro

Set up

- ⇒ Inventory chemicals in the storage area
- ⇒ Dispose of old and phased-out products as hazardous waste
- ⇒ Buy product as needed and track the use to minimize product remaining at the end of the season
- ⇒ Write dates of when pesticides were received on stickers and place on pesticide container
- ⇒ Use the oldest products first
- ⇒ Communicate between different locations in the company to use up products in partially empty containers



➔ Do not write date directly on container, because then it cannot be returned to the supplier

SOLUTION: Spill Containment Trays & Tubs

Trays and tubs are used to separate liquid chemicals from dry chemicals and to contain spills.



Store dry chemicals on shelves above liquid chemicals and store heavier containers on lower shelves.



Paul Figueroa, WSDA



Spill response kit

Setup & Use

- ⇒ Install shelves made of non-absorbent materials such as metal, or covered with epoxy-based paint or a rubber lining
- ⇒ Select trays or tubs with enough capacity and strength to contain spilled chemicals
- ⇒ Ensure that the tub or tray material is compatible with chemicals

If you have a spill

- ⇒ Follow your workplace spill response plan for cleaning up chemical spills
- ⇒ Wear the PPE as required by the label for the spilled product
- ⇒ Place each leaky container into a clean tub or tray, clean up the spill, and decontaminate
- ⇒ Dispose of spilled product and absorption materials (booms, dams, and socks) as hazardous waste



- Use WSDA approved signs for labeling chemical storage
- Cat litter can be used as an absorbent and disposed of according to the pesticide label
- Ensure the company spill response plan and training is up-to-date
- Conduct mock spills with non-toxic materials to train handlers how to clean up a spill

Reducing Family Exposure

Workplace chemicals belong at work. They can be transferred home via a worker's car, skin, clothes, and hair. Research has found pesticide residues from work in agricultural workers' cars, homes, and children (PNASH, Lu 2000). Other researchers' evidence shows possible long-term effects in children exposed to pesticides when in the womb or very young.



Dedicated Vehicle for Handlers 35

Vacuum Station for Vehicles 36

Boot Bin 37

Work Coveralls 38

Reducing Family Exposure



- Do not transport PPE or pesticides in a personal vehicle
- Leave work boots outside the house
- Store and launder dirty work clothes at work, if possible. If not, wash separately from family laundry
- Shower at work before going home or immediately after you come home



- ◆ **Pesticide Safety Handbook, "Pesticides & the Worker" Section.**
National Institute of Environmental Health Sciences
<http://www.niehs.nih.gov/> (English)
<http://www.niehs.nih.gov/> (Spanish)

Unintentional Work-to-Home Transfer of Pesticide Residue



SOLUTION: Dedicated Vehicle for Handlers

Handlers have a vehicle that they use only for work, making sure their family members and other people do not drive or ride in it. Some workplaces choose to have one vehicle for transporting pesticide handlers to the work site from a central location.

\$\$\$



Alert!

Remind handlers that others, including family members, should not ride in the dedicated vehicle.



Two handlers were concerned about work-to-home exposure ...

... so they decided to each use their own vehicle for work, and no one else rode in it. They clean the vehicles frequently to prevent build up of pesticide dust.



"I do this so I do not take pesticide residues home and I avoid pesticide exposure outside of work; for example, food, if I take the car to go shopping."

~ Mr. Montes

Setup & Use

- ⇒ Purchase or designate vehicle for handlers
- ⇒ Train handlers on how to use this vehicle
- ⇒ Remind handlers that other workers and family members are not allowed in the vehicle



Tips

- Use vehicles that have plastic seats and rubber foot wells. It is hard to remove dust and pesticide residues from fabric and carpeting
- Provide handlers who use personal vehicles the time and supplies to wash and vacuum their vehicles at work before going home
- Handlers may opt to use their own vehicle

SOLUTION: Vacuum Station for Vehicles

This station provides vacuums at the worksite for employees to vacuum commute vehicles. Employees vacuum and clean the inside of their vehicles on a regular basis to help prevent pesticide residues from building up inside the vehicles and inadvertently being transported from work-to-home. Employers can use the station to vacuum orchard vehicles as well.



Alert!

Extra training is needed to ensure employees are using the vacuuming station regularly.

Setup & Use

- ⇒ Locate vacuum station away from pesticide handling and other farm activities, such as a corner of the office parking lot
- ⇒ Pave the area to minimize dust
- ⇒ Encourage a regular cleaning schedule for employee vehicles through reminders such as:
 - Assign workers different days of the week for vacuuming their cars
 - Provide a reminder sticker or card
- ⇒ Dispose of dust/collection bag in a plastic bag and put in the outside trash

Research Finding

Levels of pesticide residues in farmworkers' homes were lower if they vacuumed their commute vehicles at work before going home than those who did not. The more often they vacuumed, the lower amount of residues found.

PNASH, Ballou 2006



- Use a vacuum with a high efficiency particulate air filter (HEPA). This captures all the dust and prevents small dust particles that may contain pesticide residue from becoming airborne.
- Provide work time for employees to clean the vehicles

SOLUTION: Boot Bin

This is a rubber or plastic tub with a lid that is kept in the trunks of agricultural workers' personal vehicles. The agricultural worker puts his or her boots in the bin at the end of each work day. Street shoes are stored in a separate bin or clean location in the car, not in the same bin used to store work boots.



Alert! Make sure the bin is used only for work boots and other items are not placed in it. Put warning symbols on the bin.

Using a boot bin protects family members. It contains dirt from work boots that may have pesticide residues. It helps to minimize the work-to-home pesticide exposure route for families by keeping dust and dirt from work out of the vehicle and the home.

Setup & Use

- ⇒ Use a plastic box that will fit inside the trunk and is large enough to hold a pair of work boots
- ⇒ Store street shoes in a clean place or plastic bag in the vehicle
- ⇒ Instruct employees to change out of their work boots and into street shoes just before going home
- ⇒ Put the work boots in the bin and store the bin in the trunk of the car or outside of the home (garage)
- ⇒ Open the lid to dry out boots if needed
- ⇒ Clean the inside and outside of boot bins regularly with soap and water. Make sure to wear chemical resistant gloves when cleaning

Evaluation Finding

All agricultural workers who tried using a boot bin provided by PNASH reported that they liked it.

PNASH, Ballou 2006



- Provide boot bins for your employees to promote minimizing work-to-home pesticide exposures
- Use a separate bin for street shoes
- Remind employees not to use boot bin for storing PPE

SOLUTION: Work Coveralls

Workers wear cotton coveralls with long sleeves over their work clothes. A clean pair is worn each workday. The coveralls are cleaned by a laundry service. Alternatively, coveralls can be laundered at work.



Alert!

Wearing both work clothes and coveralls under a PPE suit can contribute to heat stress. Wear the coveralls, but not work clothes under the PPE suit to reduce the heat load.

The coveralls protect work clothes from accumulating pesticide residues and can reduce the work-to-home transfer of these residues. Wearing coveralls under the PPE reduces the chance that the work clothes or skin could be contaminated with pesticides.

Setup & Use

- ⇒ Contract with a commercial laundry service or provide laundry facilities on the farm
- ⇒ Set up a storage space for clean and dirty coveralls
- ⇒ Designate an area for workers to change
- ⇒ Ensure work coveralls are not taken home

Evaluation Finding

One study found that an extra layer of clothing is protective. It recommends wearing coveralls over work clothes to prevent pesticide residues from accumulating on clothing.

Bradman, 2009



- Provide a locker room for changing into clean coveralls
- Provide a hamper for dirty coveralls

Reducing Exposures to Pesticides



Remember, PPE protects best when it is

- **Fitted** properly to the handler
- **Inspected** before each use to check for wear and tear
- **Worn** and **used** correctly
- **Decontaminated** after each use
- **Maintained** and **stored** in a dry, clean location

Eliminating or reducing the source of the pesticide hazard is the best way to protect handlers. For example

- Use softer (less toxic to humans) pesticides when possible. This may reduce the need for full PPE
- Employ integrated pest management (IPM) strategies to manage pests by monitoring their populations and using cultural, mechanical, and biological controls first. Use chemical pesticide control as a last resort



PPE

- ◆ **Safety Standards for Agriculture: Personal Protective Equipment (PPE).** WA L&I
<http://www.lni.wa.gov/wisha/rules/agriculture/HTML/part-h.htm>
- ◆ **Safety Standards for Agriculture: Respirators.** WA L&I
<http://www.lni.wa.gov/WISHA/Rules/agriculture/HTML/part-y-5.htm>
- ◆ **Pesticides and Personal Protective Equipment.** Purdue University
<http://www.ppp.purdue.edu/Pubs/ppp-38.pdf>
- ◆ **Pesticide Use and your Personal Protective Equipment (PPE).** Oregon OSHA
<http://www.orosha.org/pdf/pubs/1018.pdf>
- ◆ **The Air you Breathe [Respiratory Protection].** Oregon OSHA
<http://www.orosha.org/pdf/pubs/3654.pdf>

IPM

- ◆ **Integrated Pest Management.** Washington State University Extension
<http://ipm.wsu.edu>
- ◆ **UC IPM Online.** University of California-Davis
<http://www.ipm.ucdavis.edu/index.html>
- ◆ **Apple IPM Transition Project.** Washington State University
<http://pmtip.wsu.edu>
- ◆ **Field Guide for Integrated Pest Management in Hops.** OSU, U of Idaho, WSU, USDA ARS
<http://ipm.wsu.edu/field/pdf/HopHandbook2009.pdf>
- ◆ **Vinewise.** Washington Association of Wine Grape Growers
<http://www.vinewise.org>

PPE Suits, Respirators & Boots

Look for these features:

I noticed an applicator on a neighbor's farm wearing a Nor'wester type hat under his hood. He wore the hat backwards, which created a large bill under the hood. I adopted the idea and found it was a great addition to my spray gear.

~ Ms. Schott



- Rain hat with stiff brim prevents hoods from blocking vision and dripping onto respirators

- Tall collar at neck that closes up under chin
- Roomy hoods so handlers can turn their head to check sprayers
- Lightweight durable material
- Loose fitting suits for easy movement
- Snaps on sleeves

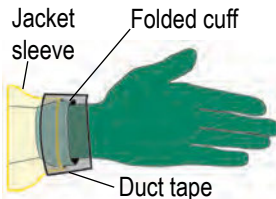

Tape glove to jacket sleeve to keep pesticides from getting in



PNASH, Keifer 2011



Research Finding

PNASH, Keifer 2011



Attached hood (no snaps)

- Powered air-purifying respirators can help keep handlers cool, provide a higher level of protection than a half-faced respirator, and some can be worn with beards



Long enough sleeves for reaching over the tank

Double flap for front closure

No pockets

- Seams that can withstand repeated decontamination



Failed jacket seam

Double knees help prevent wear and tear, especially for pesticide loaders

Check that boots are chemical resistant as not all rubber boots are

Additional Information

Please refer to your state's departments of agriculture, labor, or occupational safety and health.

National Regulations & Resources

- ⇒ Environmental Protection Agency - Protecting Workers
<http://www.epa.gov/pesticides/health/protecting-workers.html>
- ⇒ EXTOWNET - Pesticide Toxicology and Environmental Chemistry Infobase
<http://extownet.orst.edu/faqs/index.htm>
- ⇒ National Pesticide Information Center (NPIC), Information and consultation (Spanish and English) (800) 858-7378
<http://www.npic.orst.edu/>
- ⇒ Occupational Safety and Health Administration (OSHA)
<http://www.osha.gov/>

Washington State Regulations & Resources

- ⇒ Washington State Department of Agriculture - Pesticides
<http://www.agr.wa.gov/Portals/PF>
- ⇒ Washington State Department of Health Pesticide Program
<http://www.doh.wa.gov/ehp/pest/about.htm>
- ⇒ Washington State University Pesticide Safety Education Program - Certification and Training
<http://pep.wsu.edu/>
- ⇒ Washington State Department of Labor and Industries - Agriculture
<http://www.lni.wa.gov/Safety/Topics/AtoZ/topic.asp?KWID=353>
- ⇒ Washington Poison Center, (800) 222-1222; (800) 572-0638
<http://www.wapc.org/>
- ⇒ Washington State Department of Labor and Industries - Cholinesterase Monitoring
<http://www.lni.wa.gov/Safety/Topics/AtoZ/Cholinesterase/default.asp>

Heat Related Illness Educational Materials

- ⇒ NOAA's Heat Watch
<http://www.noaawatch.gov/themes/heat.php>
- ⇒ OSHA's Campaign to Prevent Heat Illness in Outdoor Workers
<http://www.osha.gov/SLTC/heatillness/index.html>
- ⇒ Pacific Northwest Agricultural Safety and Health Center
http://depts.washington.edu/pnash/heat_illness.php
- ⇒ Washington State Department of Labor and Industries
<http://www.lni.wa.gov/Safety/Topics/AtoZ/HeatStress/>

General Pesticide Safety Educational Materials

- ⇒ Agricultural Health Study
<http://aghealth.nci.nih.gov>
- ⇒ Migrant Clinician's Network
<http://www.migrantclinician.org/issues/occupational-health.html>
- ⇒ The National Agricultural Safety Database (NASD) is an online collection of information about health, safety and injury prevention in agriculture
<http://www.cdc.gov/niosh/nasd.html>
- ⇒ National Pesticide Applicator Certification Core Manual
<http://www.nasda.org/workersafety/>
- ⇒ Pacific Northwest Agricultural Safety and Health Center - Pesticides Scientific Evidence & Educational Tools
http://www.depts.washington.edu/pnash/pesticides_health
- ⇒ Pesticide Action Network offers a database about various pesticides and effects
<http://www.pesticideinfo.org/Index.html>
- ⇒ Washington State Department of Labor and Industries has courses and videos available free of charge
<http://www.lni.wa.gov/Safety/TrainTools/Videos/>
- ⇒ The Washington Environmental Stewardship website (PES) provides recommendations for proper pesticide handling
<http://www.pesticidestewardship.org/Pages/default.aspx>

NATIONAL HOTLINES

National Pesticides Information Center
(800) 858-7378
<http://npic.orst.edu>

National Poison Control Center Hotline
(800) 222-1222

PRACTICAL SOLUTIONS FOR PESTICIDE SAFETY
PACIFIC NORTHWEST AGRICULTURAL SAFETY AND HEALTH CENTER



Bibliography

Bradman A, Salvatore A, Boeniger M, Castorina R, Snyder J, Barr D, Jewell N, Kavanagh-Baird G, Striley C, Eskenazi B. *Community-Based Intervention to Reduce Pesticide Exposure to Farmworkers and Potential Take-Home Exposure to their Families*. *Journal of Exposure Science and Environmental Epidemiology*. 2009;19:79-89.

Curwin BD, Hein MJ, Sanderson WT, Nishioka M, Buhler W. *Acephate Exposure and Decontamination on Tobacco Harvesters' Hands*. *Journal of Exposure Analysis and Environmental Epidemiology*. 2003;13:203-210.

Hoheisel G and Granger K. *Lessons Learned and Initial Evaluation of a Pessl Spray Calibration Machine on Ground Sprayers*. Poster by Washington State University Extension. 2009.

Montana State University Extension. *Avoiding Pesticide Drift*. 2008. <http://www.pesticides.montana.edu/Reference/Drift.htm> accessed on 14 September 2011.

PNASH

Ballow C. *An Intervention Aiding in the Reduction of Organophosphorus Pesticides from Take-home Pathways*. MS Thesis, University of Washington Department of Environmental and Occupational Health Sciences. 2006 June.

Curl CL, Fenske RA, Kissel JC, Shirai JH, Moate TF, Griffith W, Coronado G, Thompson B. *Evaluation of Take-home Organophosphorus Pesticide Exposure among Agricultural Workers and their Children*. *Environmental Health Perspectives*. 2002 Dec;110(12):A787-92.

Jansen C, Keifer M, Murphy-Robinson H, University of Washington, Washington Departments of Agriculture, Health and Labor and Industries. *Using Data to Identify and Address Causes of Pesticide Over-exposure in Washington State Agricultural Employees*. Poster Presentation at Western Migrant Stream Forum, Seattle, WA. 2010 Feb.

Keifer M, Krenz J, Smith T, Hoffman J, Cunningham R, Simpson C, Fenske R. *Determinants of Serum Cholinesterase Inhibition among Agricultural Pesticide Handlers in Washington State, 2006-2011*. Manuscript in preparation 2011.

Krenz J. *Minimizing Pesticide Handler Pesticide Exposure: Practical Solutions Fresh from the Orchard*. MPH Thesis, University of Washington Department of Environmental and Occupational Health Sciences. 2010 June.

Lu C, Fenske RA, Simcox NJ, Kalman D. *Pesticide Exposure of Children in an Agricultural Community: Evidence of Household Proximity to Farmland and Take Home Exposure Pathways*. *Environmental Research*. 2000 Nov;84(3):290-302.

Washington State Department of Labor and Industries. *Cholinesterase Monitoring of Pesticide Handlers in Agriculture: 2007 Report*. 2007 Dec 20.

Washington State Department of Labor and Industries. *Cholinesterase Monitoring of Pesticide Handlers in Agriculture: 2008 Report*. 2008 Dec 20.

Washington State Department of Labor and Industries. *Cholinesterase Monitoring of Pesticide Handlers in Agriculture: 2009 Report*. 2009 Nov 20.

Washington State Department of Health. *Contributing Factors to Pesticide Related Illness among Agricultural Workers in Washington State, 2003-2008*. DOH 333-172 Sept 2010.

Acknowledgements

THANK YOU to the 25 farms and 95 growers, managers, handlers, and safety educators who shared their innovative ideas.

These solutions are a testament to the impressive level of care and dedication in our farming communities.

Expert Working Group (EWG)

A dedicated team of 17 pesticide handlers, farm managers, owners, and pesticide safety educators who provided practical solutions and advised on farm practices and needs. This and additional hands-on development and field-testing at several of your farms make the solutions in this guide truly “Farm Tested.” The EWG was at the heart of this project, keeping us focused on practical and realistic solutions for use in agricultural workplaces throughout the five year project.

Regional Advisory Committee for the Guide

A group of 10 professionals from industry, government agencies, non-governmental organizations, commercial suppliers, growers, and agricultural extension reviewed the developing guide on final safety, regulatory and communication issues. Their expertise and suggestions for improvement were essential to the guide.

Conference Audiences

Thank you to the over 1000 managers, pesticide handlers and agricultural safety and health professionals who evaluated solutions using multiple choice “clickers” during industry presentations. The feedback on interest, practicality, and uniqueness of proposed solutions guided the project teams and advisors.

Evaluation Survey Participants

We are grateful to the 29 managers and pesticide safety educators who conducted a detailed evaluation of potential solutions. Their time and honesty was indispensable in making decisions on what solutions to modify and include in the guide.

PNASH Project Team

The idea for the **Practical Solutions for Pesticide Safety** guide arose from what we observed at farms during previous research projects. We knew of farms that developed their own pesticide safety measures and had new ways of implementing old ones. We were inspired to identify and evaluate these “farm grown” solutions and share them with the agricultural community. Working with the support and participation of the agricultural community was essential to the project’s success and extremely gratifying for PNASH faculty, staff, and students. Thank you.

A special thank you to the **Washington State Department of Agriculture’s Farmworker Education Program** and **Washington State University Extension** for your support throughout the project.

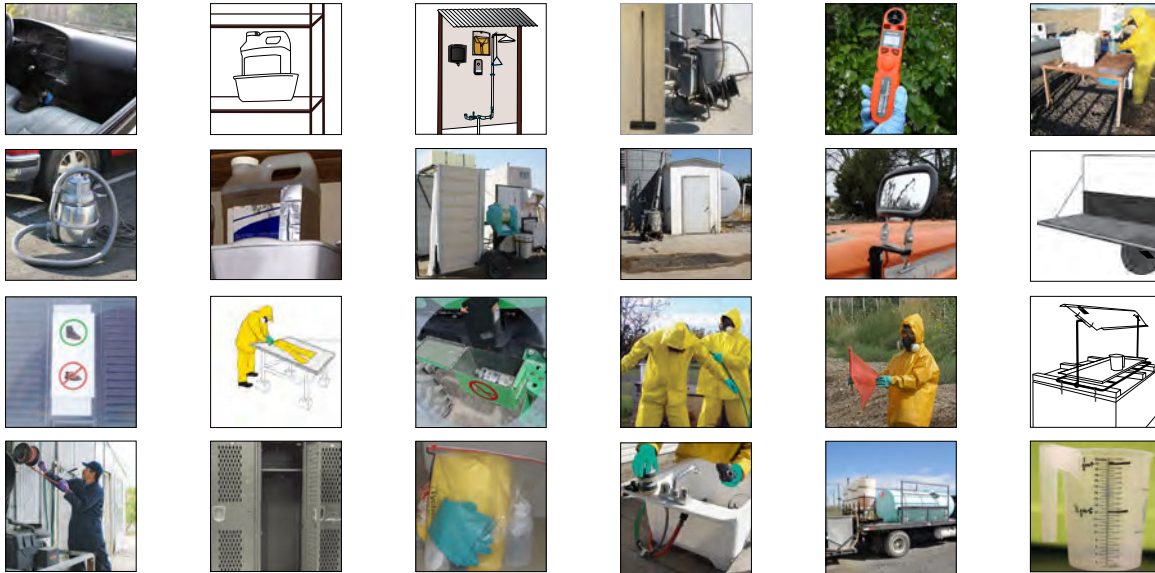

2012

**PACIFIC NORTHWEST AGRICULTURAL
SAFETY AND HEALTH (PNASH) CENTER**

School of Public Health, University of Washington
National Institute of Occupational Safety and Health Award #2 U50 OH07544

Practical Solutions for Pesticide Safety

© 2012 University of Washington
First edition, first printing

Permission is granted to reprint and distribute, provided that this copyright notice and permission statement is retained. Unless otherwise noted, photos and illustrations are the property of the PNASH Center.

Pacific Northwest Agricultural Safety and Health Center
Dept. of Environmental and Occupational Health Sciences
University of Washington, Box 357234
Seattle, WA 98195-7234 USA
(206) 616-1958, (800) 330-0827
pnash@uw.edu
<http://depts.washington.edu/pnash/>

The Practical Solutions for Pesticide Safety guide was created by the University of Washington (UW) Pacific Northwest Agricultural Safety and Health Center, under the lead of Richard Fenske, PhD, MPH, Principal Investigator. This project was funded through a cooperative agreement with the National Institute of Occupational Safety and Health (NIOSH/CDC) Award #2 U50 OH07544.

Disclaimers: The contents of this publication are solely the responsibility of the authors and do not necessarily represent the official views of NIOSH/CDC, UW, WSDA, or WSU. Mention of any company of product does not constitute endorsement.

Printed on 100% post-consumer recycled paper